

LTC4274

Single Port IEEE802.3at PSE

DESCRIPTION

Demonstration circuit 1567B features the [LTC®4274](#), a single power sourcing equipment (PSE) controller designed for use in IEEE 802.3 Type 1 and Type 2 (high power) compliant Power over Ethernet (PoE) systems. The LTC4274 is configured in the DC1567B as a midspan power injector where data comes in from an existing network system and out, along with power, to a powered device (PD). The LTC4274 autonomously detects and classifies a PD, turns power on to the port, and disconnects port power without the need for a microcontroller. A two second backoff timer supports the midspan configuration.

Only a single 55V supply is required to power the DC1567B. A simple regulator circuit on the board powers the digital supply of the LTC4274.

The LTC4274 delivers low heat dissipation by utilizing a low R_{ON} external MOSFET and a 0.25Ω sense resistor, eliminating the need for expensive heat sinks. An external MOSFET also provide a more robust solution compared to an integrated MOSFET.

Power controlled by the LTC4274 is connected to the center taps on the cable side of the Ethernet transformers for data pairs 4/5 and 7/8. An integrated RJ45 connector includes the Ethernet transformer, common mode termination, and LEDs. One LED is also controlled by the LTC4274 to indicate the port is powered. Test turrets provide test points for port power measurements.

The DC1567B has increased surge protection from the DC1567A.

Design files for this circuit board are available at <http://www.linear.com/demo/DC1567B>

LT, LT, LTC, LTM, Linear Technology and the Linear logo are registered trademarks of Linear Technology Corporation. All other trademarks are the property of their respective owners.

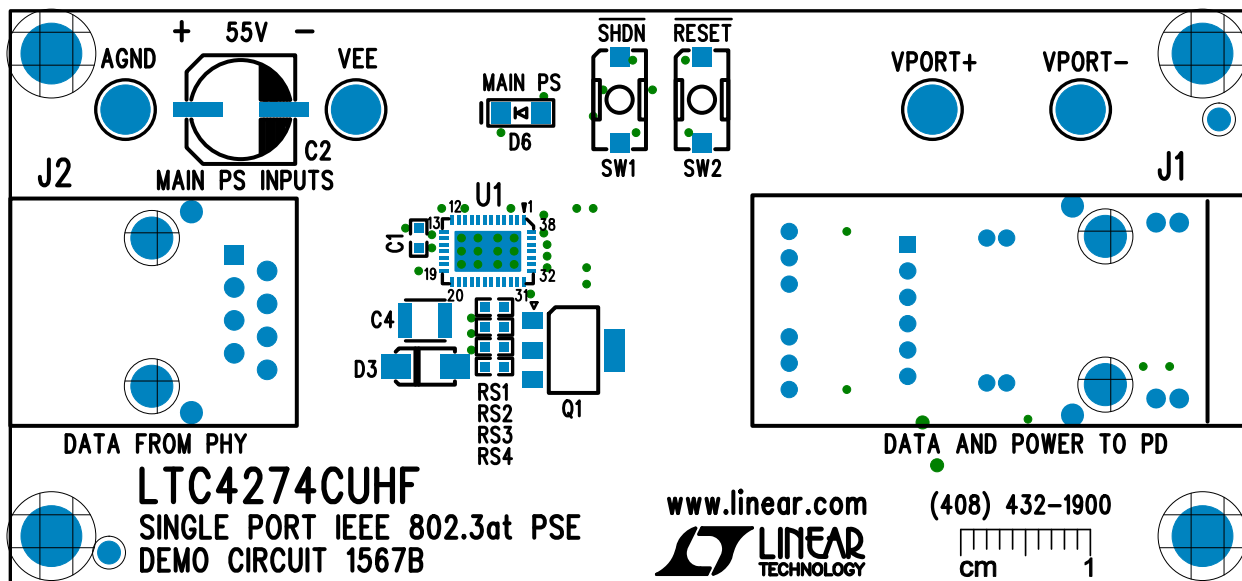

TYPICAL PERFORMANCE

Table 1. Typical DC1567B Performance Summary ($T_A = 25^\circ\text{C}$)

PARAMETER	CONDITION	VALUE
Input Voltage	GND – V_{EE} , Typical Voltage, IEEE Type 1 and Type 2 Complaint Output	51V to 57V
V_{DD} Supply Voltage	V_{DD} – DGND, Generated on Demo Board from V_{EE}	3.4V to 3.8V
Powered Pairs	PoE Power at RJ45 Connector	Alternative-B (Positive on Pins 4/5, Negative on 7/8)
PSE Operation Mode	AUTO Pin Logic High	IEEE802.3at Mode
Midspan Backoff	MID Pin Logic High, Backoff Time After Detection	2.5s
Detection Type	25k Signature Detection	4-Point PD Detection
	Class 4	2-Event Classification
RJ45 Amber LED Indicator	PD Detected and Port Power is On	LED On
	Port Power is Off	LED Off
Port Output Voltage	$V_{EE} = -55.0\text{V}$, $R_{SENSE} = 0.25\Omega$, MOSFET = PHT6NQ10T, Port Load = 600mA, $V_{PORT+} - V_{PORT-}$	-54.7V
Disconnect Current	DC Disconnect, Maintain Power Signature, Typical Disconnect Current at the Port for 350ms, $R_{SENSE} = 0.25\Omega$	<7.8mA
AUTO Pin High Mode Overcurrent Sense	$R_{SENSE} = 0.25\Omega$, Class 0 or Class 3	376mA
	$R_{SENSE} = 0.25\Omega$, Class 1	112mA
	$R_{SENSE} = 0.25\Omega$, Class 2	208mA
	$R_{SENSE} = 0.25\Omega$, Class 4	636mA

QUICK START PROCEDURE (Figure 1)

1. Connect a 55V power supply across AGND and V_{EE} as shown in Figure 1.
2. Connect probes across VPORT+ and VPORT- for measurements.
3. Connect with a CAT5 cable to a PD at J1.
4. Connect a PHY with a CAT5 cable to J2 for data testing (optional).

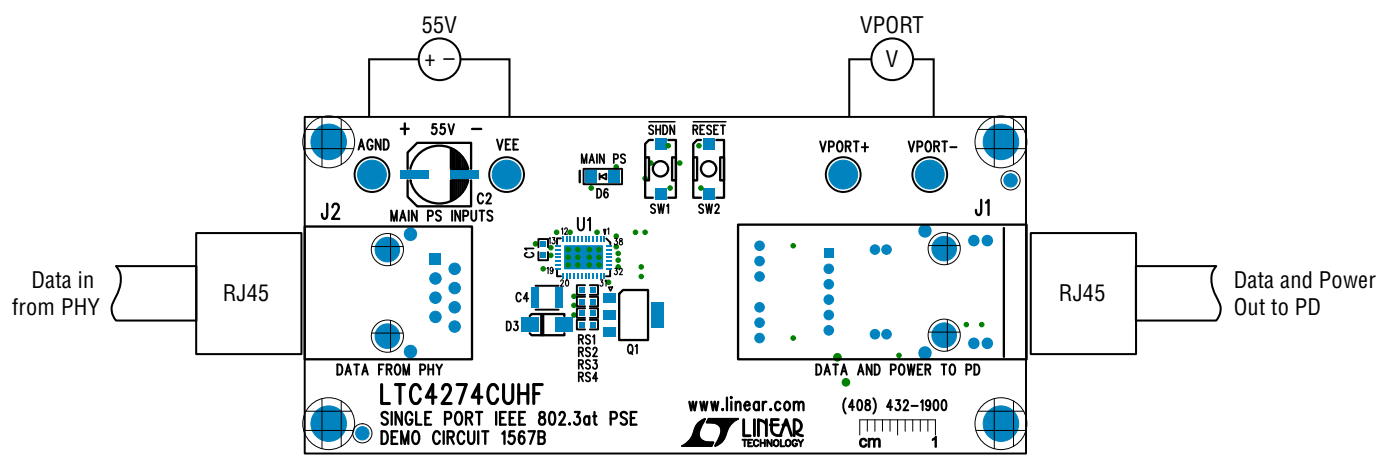

Figure 1. DC1567B Setup

OPERATION

DC1567B provides a simple single port IEEE 802.3at Type 1 and Type 2 PSE solution with the LTC4274. It runs fully autonomously and only requires a supply at V_{EE} . Detection, classification, port power on and disconnect is all performed without the need of a microcontroller. The voltage drop to the port is minimized with the LTC4274 solution because of the low R_{ON} external MOSFET and a 0.25Ω sense resistor, thus reducing power consumption.

Input Supply

IEEE 802.3at requires that a Type 2 PSE output at the port between 50V to 57V. To meet this requirement, it is recommended to supply a nominal 55V across AGND and V_{EE} on the DC1567B as shown in Figure 1. Main PS LED indicates the input power supply is powering the LTC4274.

V_{DD} Supply

DC1567B generates a V_{DD} supply from V_{EE} using just three components allowing for V_{EE} to be the only required supply. V_{DD} is tied to AGND and DGND is a negative voltage below AGND.

AUTO Pin High Mode

The AUTO pin on the LTC4274 is tied logic high on the DC1567B to set the device to AUTO pin high mode. In AUTO pin high mode, the LTC4274 autonomously detects, classifies, powers on a valid detected PD, and disconnects power to the port when the PD is removed. An LED in the integrated RJ45 connector displays if the port is powered.

Midspan

The LTC4274 on the DC1567B, the MID pin is tied logic high to set the device to midspan mode. In midspan mode, port detection occurs every midspan backoff time of 2.5s.

Detection and Classification

The LTC4274 performs 4-point PD detection with 2-point forced voltage and 2-point forced current for higher reliability of valid PD detection. Once a valid PD is detected, classification is carried out. The LTC4274 in AUTO pin high mode detects and classifies class 0 through class 4 PDs and sets the port current limits according to the PD class. In the event a class 4 is detected, the LTC4274 outputs a 2-Event classification to signal to the PD that it is a valid IEEE 802.3at PSE and can supply the high power.

Disconnect

The LTC4274 performs DC disconnect. In order for a PD to remain on, it must display a maintain power signature by drawing more than 10mA. If the port load is less than 5mA for 350ms (typ), then the LTC4274 will remove power from the port.

Overcurrent

The LTC4274 in AUTO pin high mode detects, classifies and sets the current limits according to the classification results. Refer to Table 1 for the overcurrent limits with a 0.25Ω sense resistor.

\overline{SHDN} and \overline{RESET} Pushbuttons

The DC1567B has pushbuttons to the LTC4274 \overline{SHDN} , \overline{RESET} and DGND pins. Momentarily tying \overline{SHDN} to DGND will shut down the port if it is on and disable detection preventing the port from turning on again. Momentarily tying \overline{RESET} to DGND will reset the LTC4274 to its AUTO pin high mode state without having to cycle power.

SURGE PROTECTION

Ethernet ports can be subject to significant cable surge events. To keep PoE voltages below a safe level and protect the application against damage, protection components are required at the main supply, at the LTC4274 supply pins and at the port.

Bulk transient voltage suppression devices and bulk capacitance are required across the main PoE supply and should be sized to accommodate system level surge requirements. The DC1567B diode D2 and capacitor C2 are example components for this protection at the main PoE supply.

The LTC4274 requires a 10Ω , 0805 resistor (R10) in series from supply AGND to the LTC4274 AGND pin. Across the LTC4274 AGND pin and V_{EE} pin are an SMAJ58A, 58V TVS (D3) and a $1\mu\text{F}$, 100V bypass capacitor (C4). These components must be placed close to the LTC4266 pins.

The port requires a pair of S1B clamp diodes: one from OUT to supply AGND and one from OUT to supply V_{EE} . The diodes at the ports steer harmful surges into the supply rails where they are absorbed by the surge suppressors and the V_{EE} bypass capacitance. The layout of these paths must be low impedance.

SCHEMATIC DIAGRAM

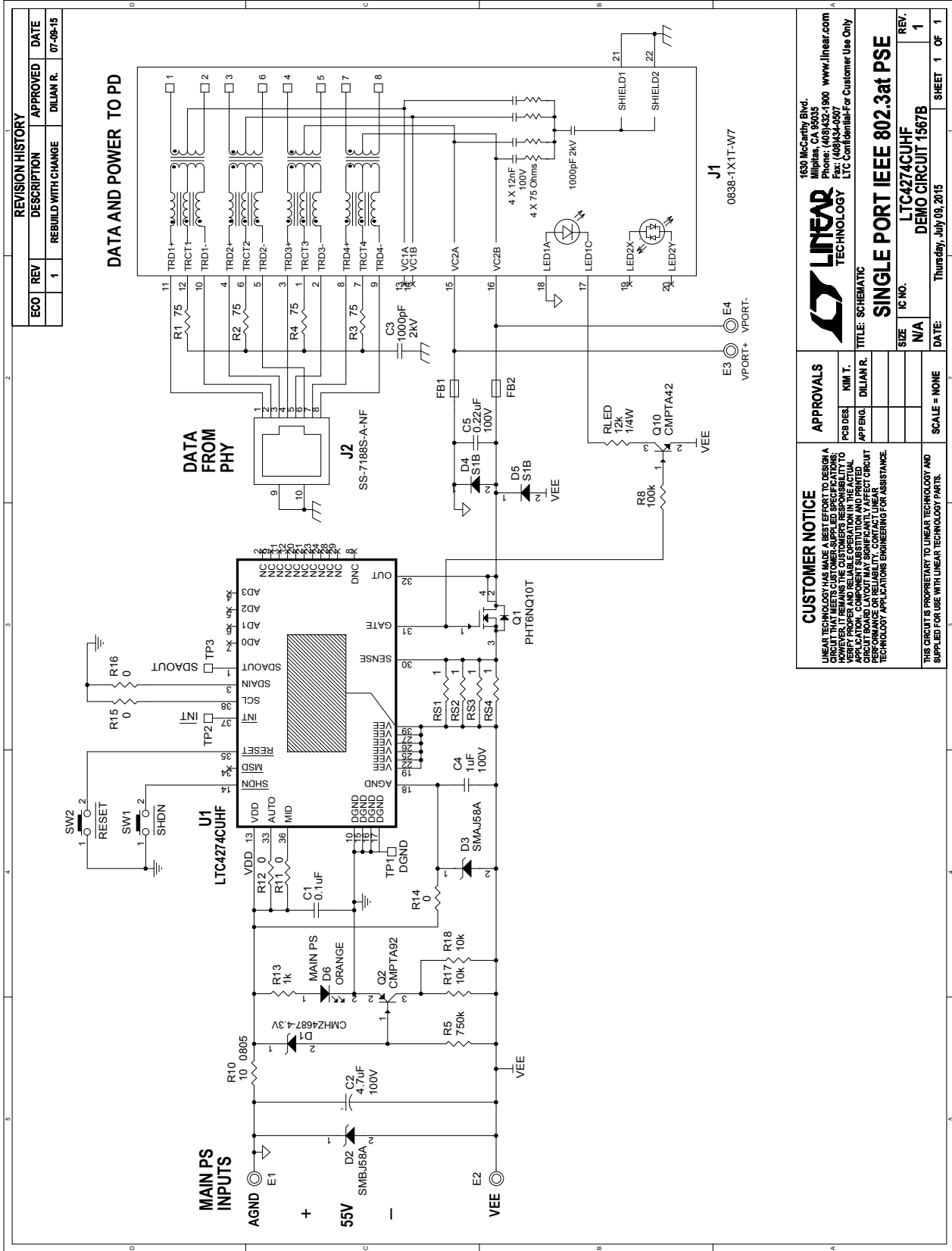

CUSTOMER NOTICE
 LINEAR TECHNOLOGY HAS MADE A BEST EFFORT TO DESIGN A CIRCUIT THAT MEETS OUR CUSTOMER'S SPECIFICATIONS. WE DO NOT WARRANT OR MAKE ANY REPRESENTATIONS REGARDING THE USE OF THIS CIRCUIT OR THE RESULTS OBTAINED FROM ITS USE. THE USER ASSUMES ALL LIABILITY FOR ANY DAMAGE TO PERSONS OR PROPERTY ARISING FROM ANY USE OF THIS CIRCUIT. VERIFY PROPER AND RELIABLE OPERATION IN THE ACTUAL APPLICATION. COMPONENT SUBSTITUTION AND PRINTED CIRCUIT BOARD MANUFACTURING VARIATIONS MAY AFFECT PERFORMANCE OR RELIABILITY. CONTACT LINEAR TECHNOLOGY APPLICATIONS ENGINEERING FOR ASSISTANCE.

APPROVALS

PCB DES.	KIM T.
APP'NG.	DILIAN R.

LINEAR TECHNOLOGY
 1650 McCarthy Blvd.
 Milpitas, CA 95035
 Phone: (408)432-1900 www.linear.com
 Fax: (408)434-0907
 LTC Confidential-For Customer Use Only

TITLE: SCHEMATIC
SINGLE PORT IEEE 802.3at PSE

SIZE	C NO.	REV.
N/A		1
DATE:	Thursday, July 09, 2015	SHEET 1 OF 1

THIS CIRCUIT IS PROPRIETARY TO LINEAR TECHNOLOGY AND SUPPLIED FOR USE WITH LINEAR TECHNOLOGY PARTS.

PCB LAYOUT AND FILM

Top Assembly

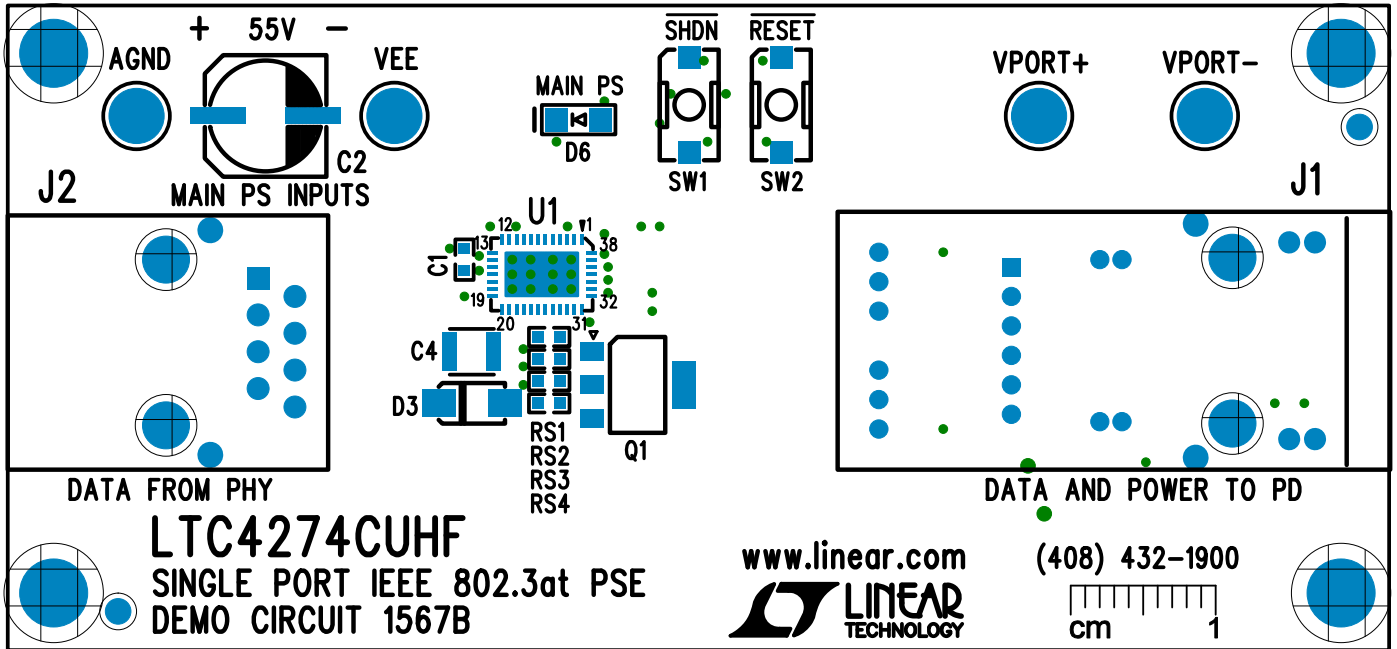

Top Side

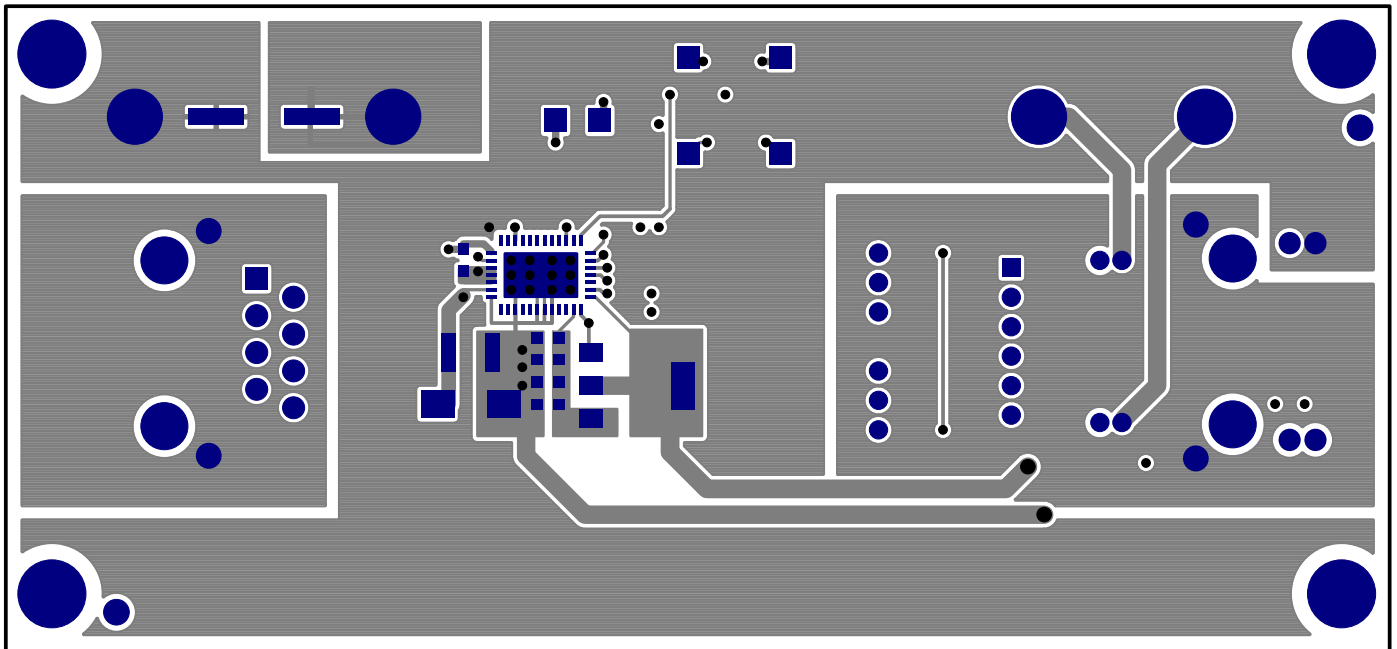

PCB LAYOUT AND FILM

Inner Layer 2

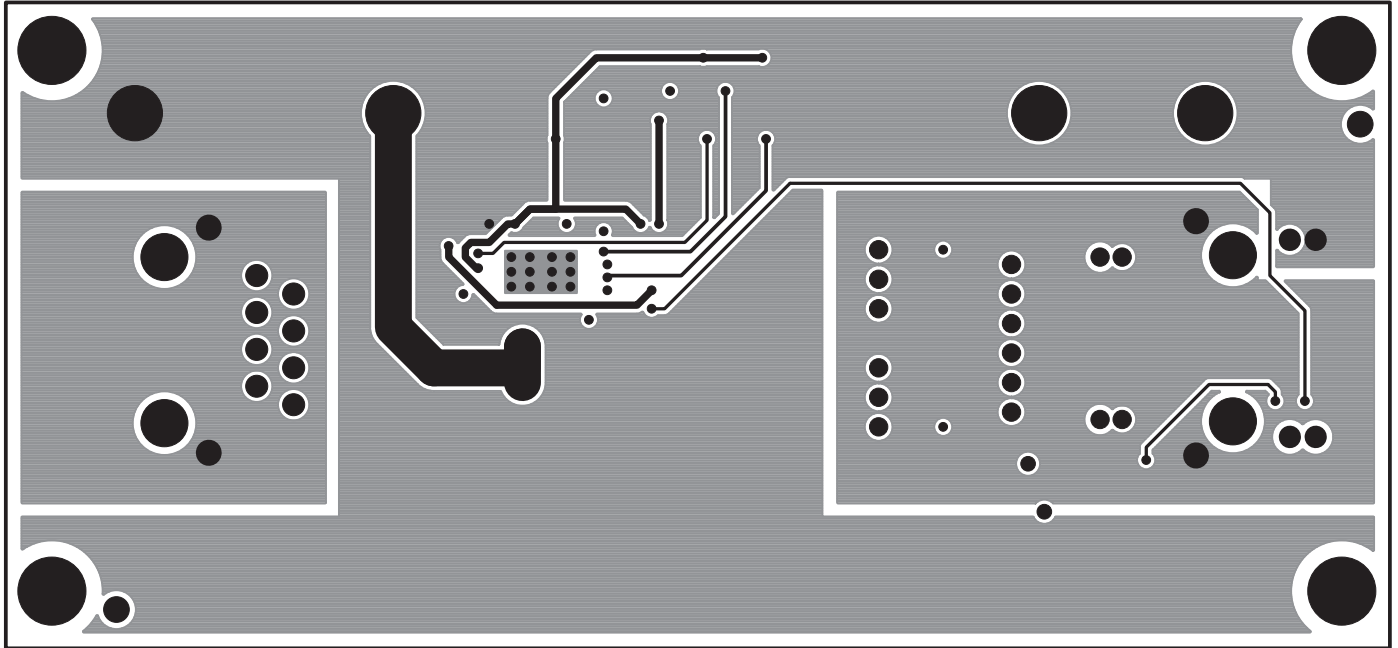

Inner Layer 3

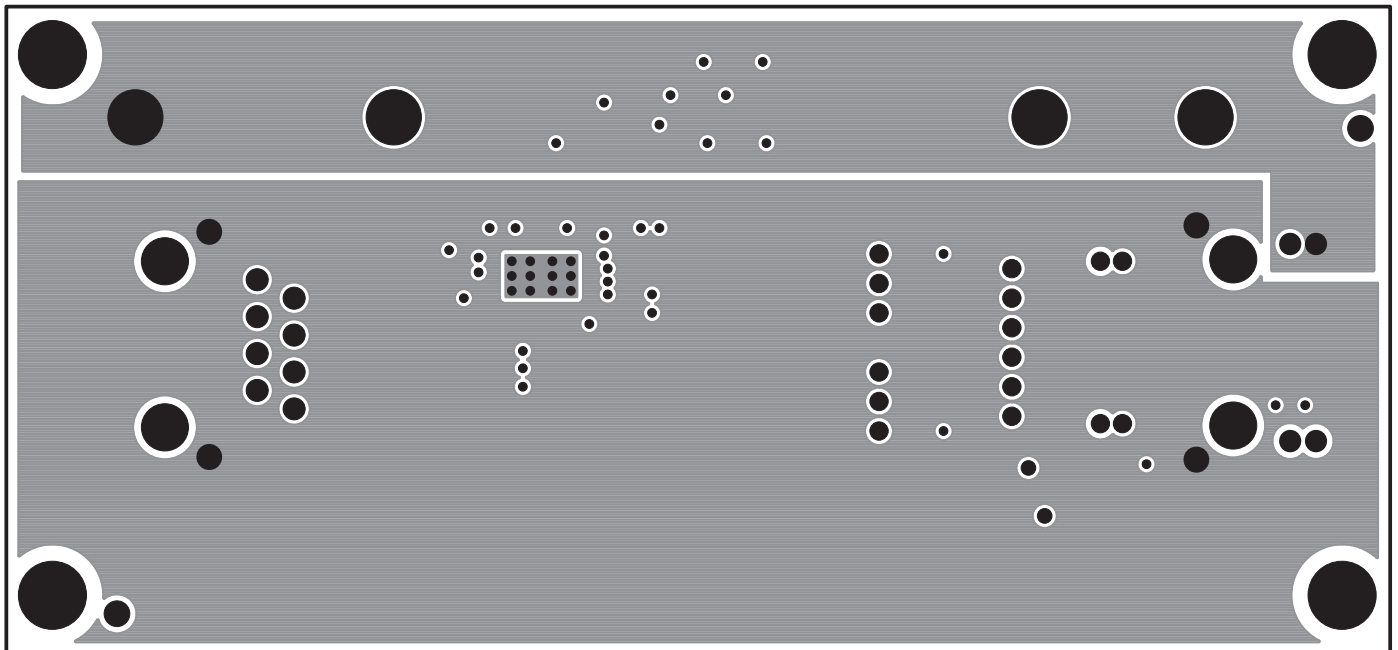

PCB LAYOUT AND FILM

Bottom Side

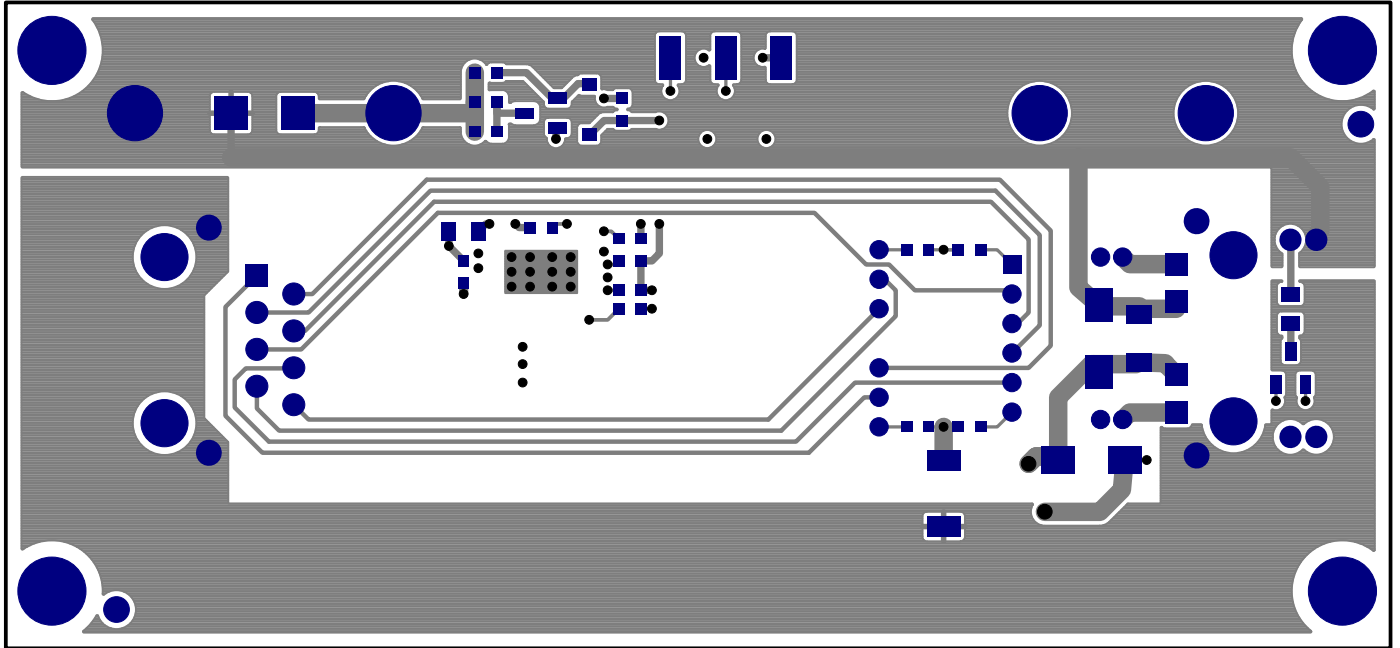

Assembly Bottom

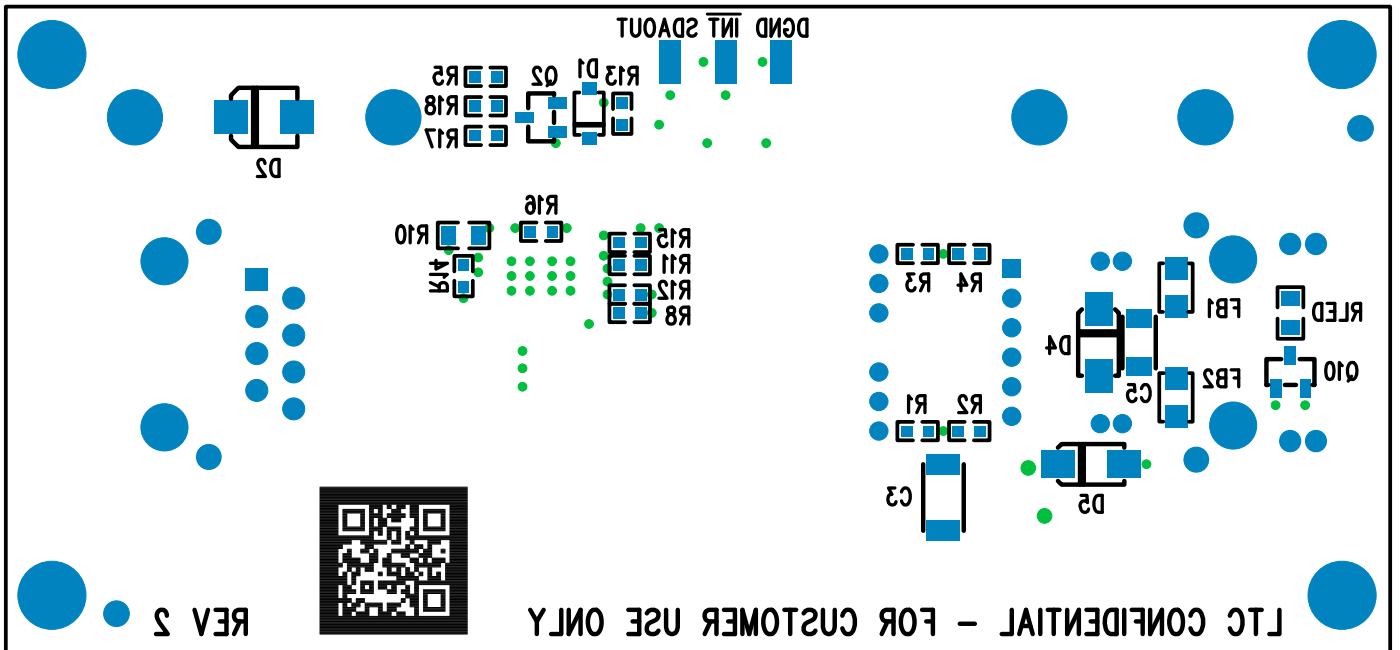

DEMO MANUAL DC1567B

DEMONSTRATION BOARD IMPORTANT NOTICE

Linear Technology Corporation (LTC) provides the enclosed product(s) under the following **AS IS** conditions:

This demonstration board (DEMO BOARD) kit being sold or provided by Linear Technology is intended for use for **ENGINEERING DEVELOPMENT OR EVALUATION PURPOSES ONLY** and is not provided by LTC for commercial use. As such, the DEMO BOARD herein may not be complete in terms of required design-, marketing-, and/or manufacturing-related protective considerations, including but not limited to product safety measures typically found in finished commercial goods. As a prototype, this product does not fall within the scope of the European Union directive on electromagnetic compatibility and therefore may or may not meet the technical requirements of the directive, or other regulations.

If this evaluation kit does not meet the specifications recited in the DEMO BOARD manual the kit may be returned within 30 days from the date of delivery for a full refund. **THE FOREGOING WARRANTY IS THE EXCLUSIVE WARRANTY MADE BY THE SELLER TO BUYER AND IS IN LIEU OF ALL OTHER WARRANTIES, EXPRESSED, IMPLIED, OR STATUTORY, INCLUDING ANY WARRANTY OF MERCHANTABILITY OR FITNESS FOR ANY PARTICULAR PURPOSE. EXCEPT TO THE EXTENT OF THIS INDEMNITY, NEITHER PARTY SHALL BE LIABLE TO THE OTHER FOR ANY INDIRECT, SPECIAL, INCIDENTAL, OR CONSEQUENTIAL DAMAGES.**

The user assumes all responsibility and liability for proper and safe handling of the goods. Further, the user releases LTC from all claims arising from the handling or use of the goods. Due to the open construction of the product, it is the user's responsibility to take any and all appropriate precautions with regard to electrostatic discharge. Also be aware that the products herein may not be regulatory compliant or agency certified (FCC, UL, CE, etc.).

No License is granted under any patent right or other intellectual property whatsoever. **LTC assumes no liability for applications assistance, customer product design, software performance, or infringement of patents or any other intellectual property rights of any kind.**

LTC currently services a variety of customers for products around the world, and therefore this transaction **is not exclusive**.

Please read the DEMO BOARD manual prior to handling the product. Persons handling this product must have electronics training and observe good laboratory practice standards. **Common sense is encouraged.**

This notice contains important safety information about temperatures and voltages. For further safety concerns, please contact a LTC application engineer.

Mailing Address:

Linear Technology
1630 McCarthy Blvd.
Milpitas, CA 95035

Copyright © 2004, Linear Technology Corporation