

PXF40-xxWDxx Dual Output DC/DC Converter

9 to 36 Vdc and 18 to 75 Vdc input, ± 12 to ± 15 Vdc Dual Output, 40W



Applications

- Wireless Network
- Telecom/Datacom
- Industry Control System
- Measurement Equipment
- Semiconductor Equipment

Features

- Dual output current up to ± 1.667 A
- 40 watts maximum output power
- 4:1 ultra wide input voltage range of 9-36 and 18-75VDC
- Six-sided continuous shield
- Case grounding
- High efficiency up to 86%
- Low profile: 2.00×2.00×0.40 inch (50.8×50.8×10.2 mm)
- Fixed switching frequency
- RoHS directive compliant
- Input to output isolation: 1600Vdc,min
- Over-temperature protection
- Input under-voltage protection
- Output over-voltage protection
- Over-current protection, auto-recovery
- Output short circuit protection, auto-recovery
- Remote ON/OFF

Options

- Heat sinks available for extended operation
- Remote ON/OFF logic configuration

General Description

The PXF40-xxWDxx dual output converters offer 40 watts of output power from a 2.00 x 2.00 x 0.4 inch package. This series with a 4:1 ultra wide input voltage of 9-36VDC and 18-75VDC, features 1600VDC of isolation, short-circuit, over-voltage and over-temperature protection, as well as six sided shielding. All models are particularly suited for telecommunications, industrial, mobile telecom and test equipment applications.

Table of contents

Absolute Maximum Ratings	P2	Heat Sink Consideration	P17
Output Specification	P2	Remote ON/OFF Control	P18
Input Specification	P3	Mechanical Data	P19
General Specification	P4	Recommended Pad Layout	P19
Characteristic Curves	P5	Output Voltage Adjustment	P20
Test Configurations	P13	Soldering Consideration	P21
EMC Considerations	P14	Packaging Information	P21
Input Source Impedance	P16	Part Number Structure	P22
Output Over Current Protection	P16	Safety and Installation Instructions	P22
Output Over Voltage Protection	P16	MTBF and Reliability	P22
Thermal Consideration	P16		

Absolute Maximum Rating				
Parameter	Model	Min	Max	Unit
Input Voltage	Continuous	24WDxx	36	V_{DC}
		48WDxx	75	
	Transient (100ms)	24WDxx	50	
		48WDxx	100	
Operating Ambient Temperature (with derating)	All	-40	105	$^{\circ}C$
Operating Case Temperature	All		105	$^{\circ}C$
Storage Temperature	All	-55	125	$^{\circ}C$

Output Specification					
Parameter	Model	Min	Typ	Max	Unit
Output Voltage ($V_{in} = V_{in(nom)}$; Full Load ; $T_A=25^{\circ}C$)	xxWD12	11.88	12	12.12	V_{DC}
	xxWD15	14.85	15	15.15	
Output Regulation Line ($V_{in(min)}$ to $V_{in(max)}$ at Full Load) Load (Min. to 100% of Full Load)	All	-0.2		+0.2	%
		-1.0		+1.0	
Cross Regulation Asymmetrical Load 25% / 100% of Full Load	All	-5.0		+5.0	%
Output Ripple & Noise Peak-to-Peak (20MHz bandwidth)	xxWD12			120	mVp-p
	xxWD15			150	
Temperature Coefficient	All	-0.02		+0.02	$\%/^{\circ}C$
Output Voltage Overshoot ($V_{in(min)}$ to $V_{in(max)}$; Full Load; $T_A=25^{\circ}C$)	All			3	$\% V_{OUT}$
Dynamic Load Response ($V_{in} = V_{in(nom)}$; $T_A=25^{\circ}C$) Load step change from 75% to 100% or 100 to 75% of Full Load Peak Deviation Setting Time ($V_{OUT} < 10\%$ peak deviation)	All		200		mV
	All		250		μS
Output Current	xxWD12	± 65		± 1667	mA
	xxWD15	± 50		± 1333	
Output Over Voltage Protection (Zener diode clamp)	xxWD12		15		V_{DC}
	xxWD15		18		
Output Over Current Protection	All			150	% FL.
Output Short Circuit Protection	All	Hiccup, automatic recovery			

Input Specification						
Parameter	Model	Min	Typ	Max	Unit	
Operating Input Voltage	24WDxx	9	24	36	V _{DC}	
	48WDxx	18	48	75		
Input Current (Maximum value at V _{in} = V _{in} (nom); Full Load)	24WD12			2032	mA	
	24WD15			2032		
	48WD12			1016		
	48WD15			1016		
Input Standby Current (Typical value at V _{in} = V _{in} (nom); No Load)	24WD12		60		mA	
	24WD15		70			
	48WD12		30			
	48WD15		30			
Under Voltage Lockout Turn-on Threshold	24WDxx			9	V _{DC}	
	48WDxx			18		
Under Voltage Lockout Turn-off Threshold	24WDxx		8		V _{DC}	
	48WDxx		16			
Input Reflected Ripple Current (5 to 20MHz, 12μH Source Impedance)	All		20		mAp-p	
Start Up Time (V _{in} = V _{in} (nom) and constant resistive load)					mS	
	Power up	All		20		
	Remote ON/OFF			20		
Remote ON/OFF Control (The ON/OFF pin voltage is referenced to -V _{IN})	Negative Logic	DC-DC ON(Short)	All	0	V _{DC}	
		DC-DC OFF(Open)		3		12
	Positive Logic	DC-DC ON(Open)		3		12
		DC-DC OFF(Short)		0		1.2
Remote Off Input Current	24WDxx		10		mA	
	48WDxx		5			
Input Current of Remote Control Pin	All	-0.5		0.5	mA	

General Specification					
Parameter	Model	Min	Typ	Max	Unit
Efficiency ($V_{in} = V_{in(nom)}$; Full Load ; $T_A=25^{\circ}C$)	24WD12		86		%
	24WD15		86		
	48WD12		86		
	48WD15		86		
Isolation Voltage Input to Output Input (Output) to Case	All	1600			V_{DC}
		1600			
Isolation Resistance	All	1			GΩ
Isolation Capacitance	All			2500	pF
Switching Frequency	All		300		kHz
Weight	All		60		g
MTBF Bellcore TR-NWT-000332, $T_C=40^{\circ}C$ MIL-HDBK-217F	All		1.105×10^6		hours
			1.511×10^5		
Over Temperature Protection	All		110		$^{\circ}C$

Characteristic Curves

All test conditions are at 25°C. The figures are for PXF40-24WD12

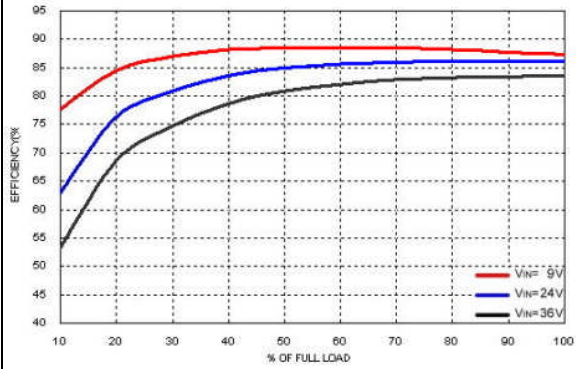

Efficiency Versus Output Current

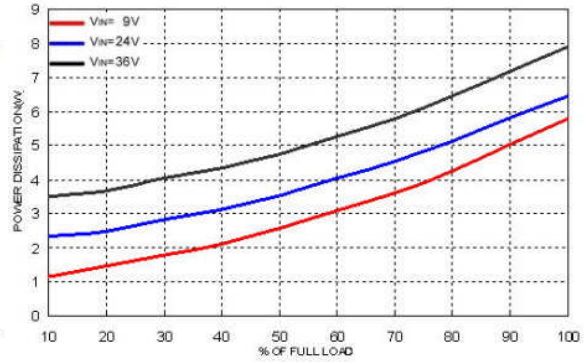

Power Dissipation Versus Output Current

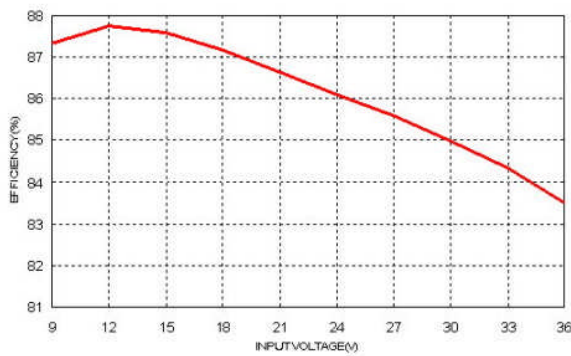

Efficiency Versus Input Voltage. Full Load

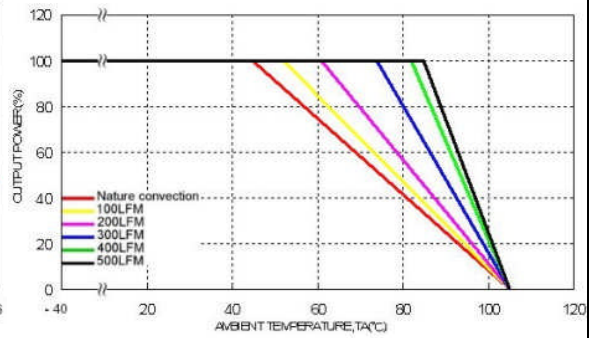

Derating Output Current Versus Ambient Temperature and Airflow $V_{in} = V_{in}(nom)$

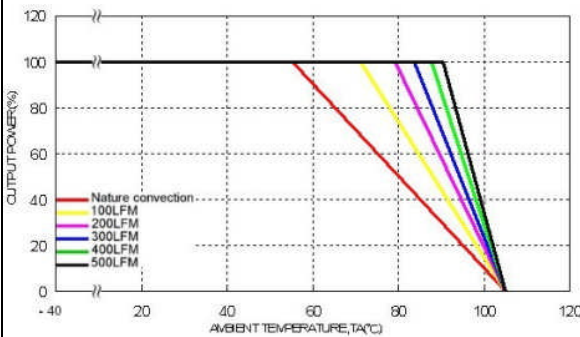

Derating Output Current Versus Ambient Temperature with Heat-Sink and Airflow, $V_{in} = V_{in}(nom)$

Characteristic Curves (Continued)

All test conditions are at 25°C. The figures are for PXF40-24WD12

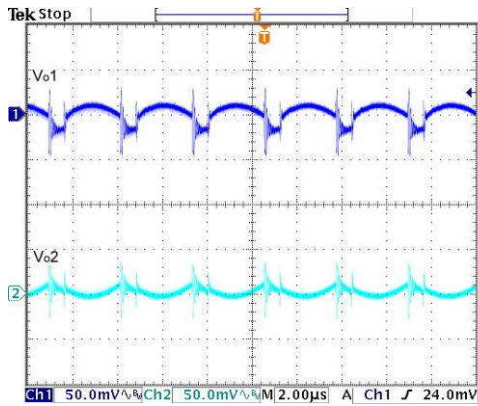

Typical Output Ripple and Noise.
Vin = Vin(nom), Full Load

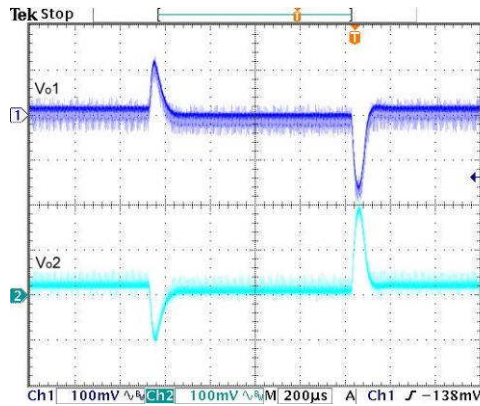

Transient Response to Dynamic Load Change from 100% to 75% to 100% of Full Load ; Vin = Vin(nom)

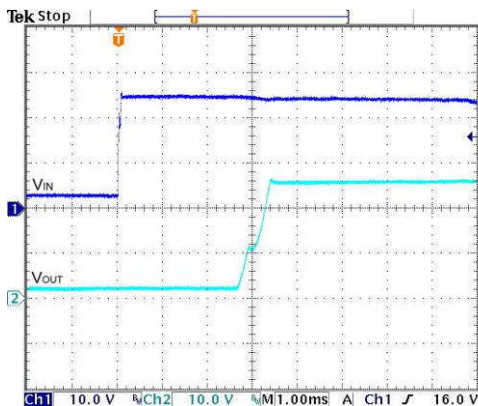

Typical Input Start-Up and Output Rise Characteristic
Vin = Vin(nom), Full Load

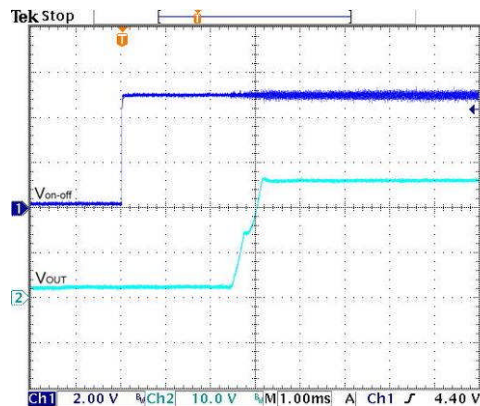

Using ON/OFF Voltage Start-Up and Vo Rise Characteristic
Vin = Vin(nom), Full Load

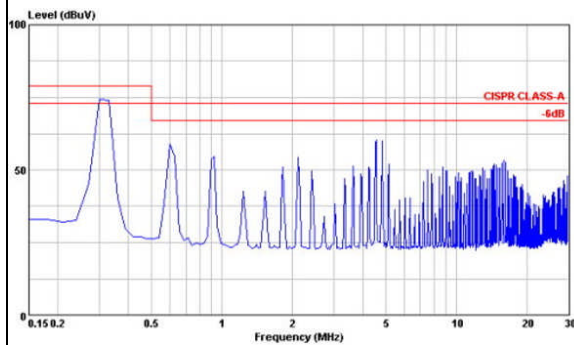

Conduction Emission of EN55022 Class A
Vin = Vin(nom), Full Load

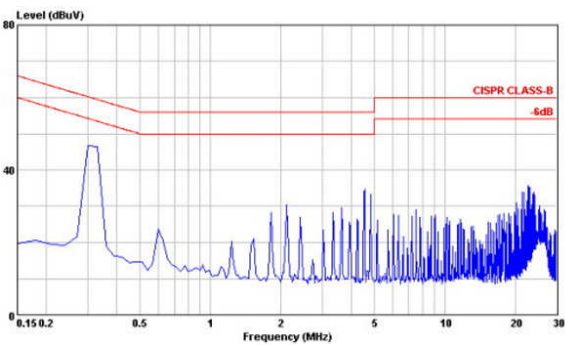

Conduction Emission of EN55022 Class B
Vin = Vin(nom), Full Load

Characteristic Curves (Continued)

All test conditions are at 25°C. The figures are for PXF40-24WD15

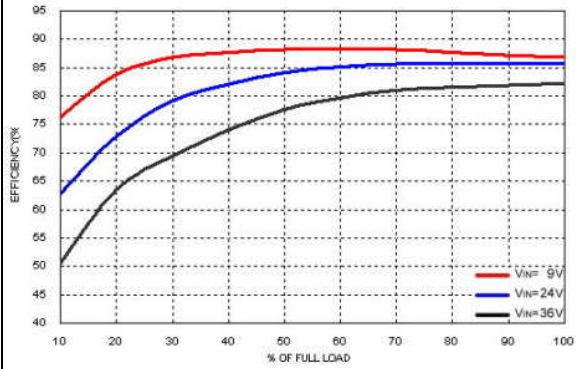

Efficiency Versus Output Current

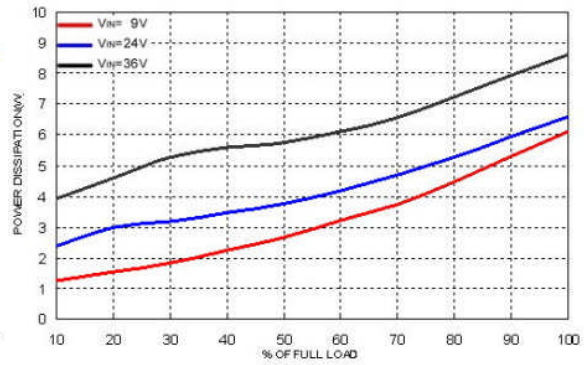

Power Dissipation Versus Output Current

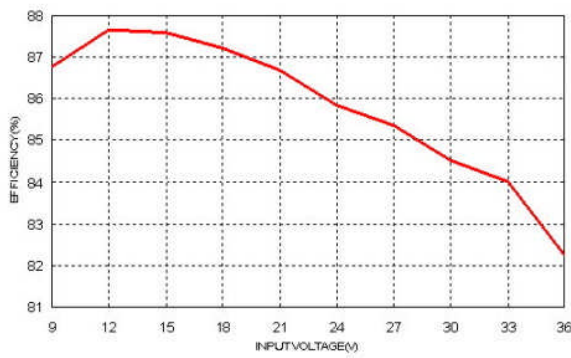

Efficiency Versus Input Voltage. Full Load

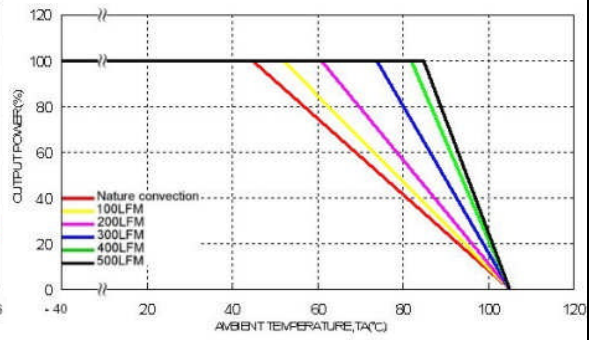

Derating Output Current Versus Ambient Temperature and Airflow $V_{in} = V_{in}(nom)$

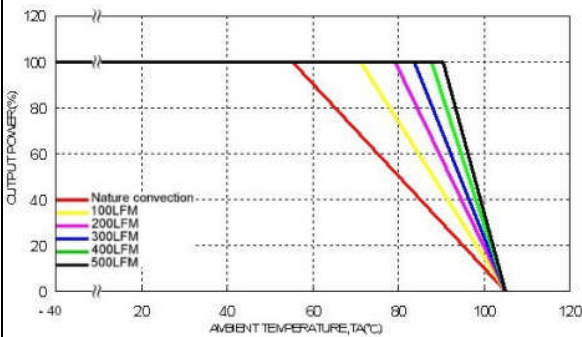

Derating Output Current Versus Ambient Temperature with Heat-Sink and Airflow, $V_{in} = V_{in}(nom)$

Characteristic Curves (Continued)

All test conditions are at 25°C. The figures are for PXF40-24WD15

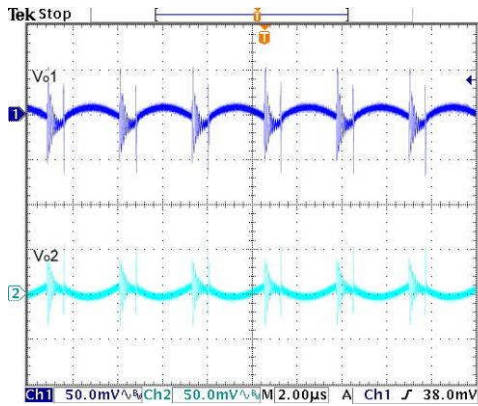

Typical Output Ripple and Noise.
 $V_{in} = V_{in(nom)}$, Full Load

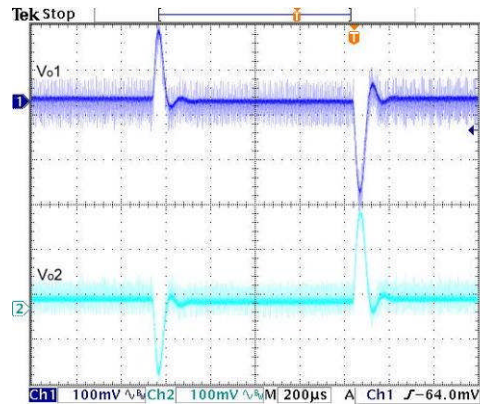

Transient Response to Dynamic Load Change from 100% to 75% to 100% of Full Load ; $V_{in} = V_{in(nom)}$

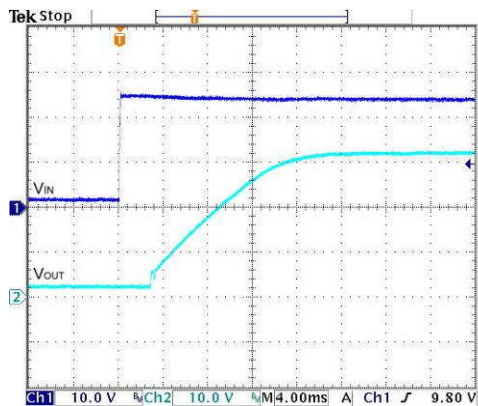

Typical Input Start-up and Output Rise Characteristic
 $V_{in} = V_{in(nom)}$, Full Load

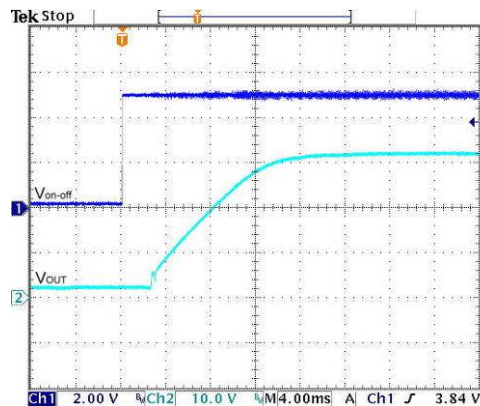

Using ON/OFF Voltage Start-up and Vo Rise Characteristic
 $V_{in} = V_{in(nom)}$, Full Load

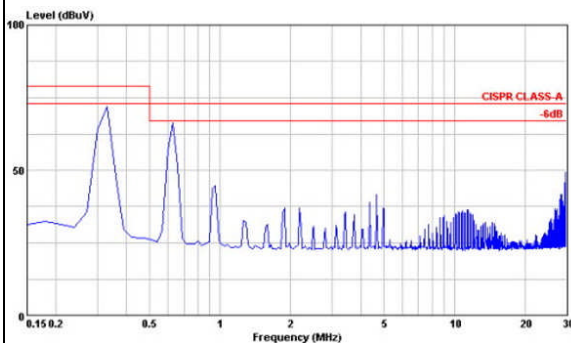

Conduction Emission of EN55022 Class A
 $V_{in} = V_{in(nom)}$, Full Load

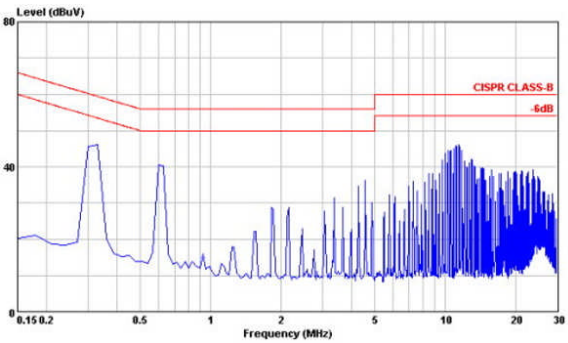

Conduction Emission of EN55022 Class B
 $V_{in} = V_{in(nom)}$, Full Load

Characteristic Curves (Continued)

All test conditions are at 25°C. The figures are for PXF40-48WD12

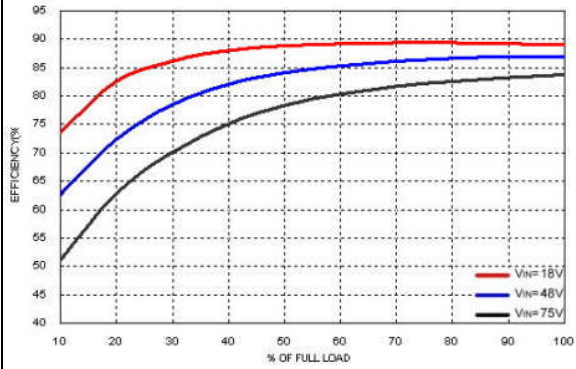

Efficiency Versus Output Current

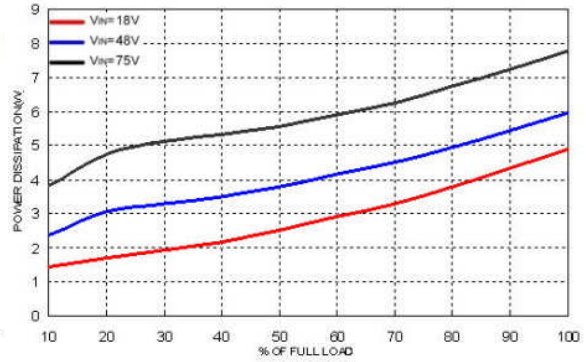

Power Dissipation Versus Output Current

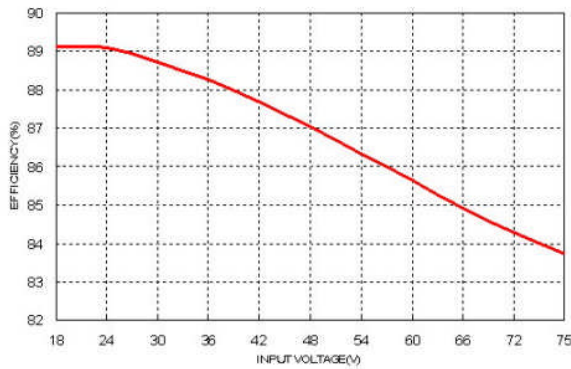

Efficiency Versus Input Voltage. Full Load

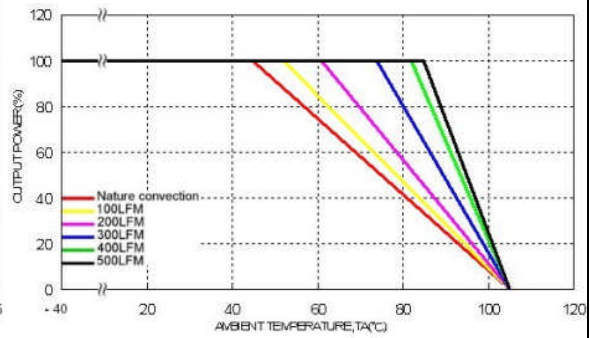

Derating Output Current Versus Ambient Temperature and Airflow $V_{in} = V_{in}(nom)$

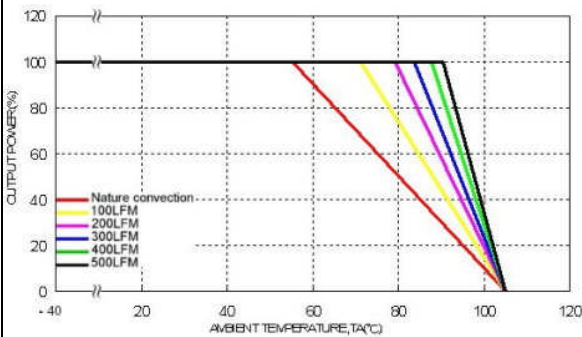

Derating Output Current Versus Ambient Temperature with Heat-Sink and Airflow, $V_{in} = V_{in}(nom)$

Characteristic Curves (Continued)

All test conditions are at 25°C. The figures are for PXF40-48WD12

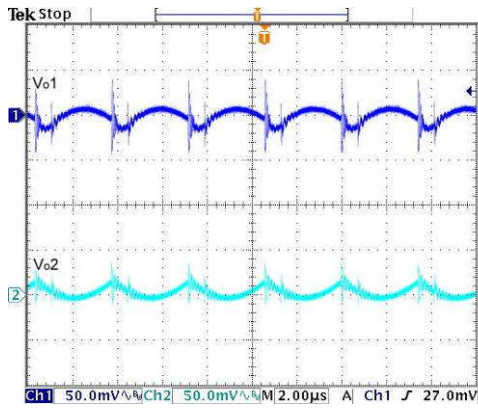

Typical Output Ripple and Noise.
Vin = Vin(nom), Full Load

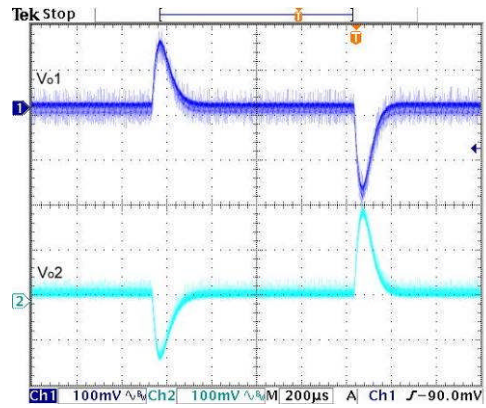

Transient Response to Dynamic Load Change from 100% to 75% to 100% of Full Load ; Vin = Vin(nom)

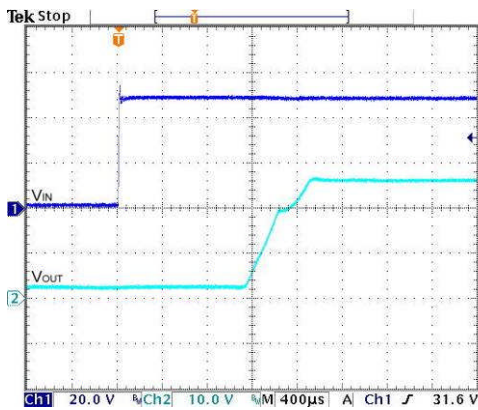

Typical Input Start-Up and Output Rise Characteristic
Vin = Vin(nom), Full Load

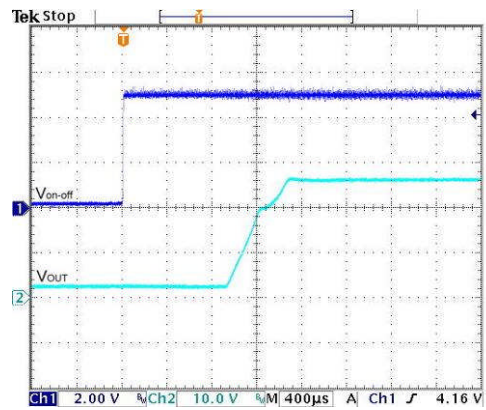

Using ON/OFF Voltage Start-Up and Vo Rise Characteristic
Vin = Vin(nom), Full Load

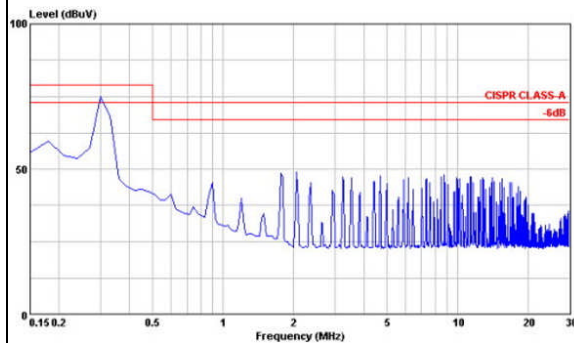

Conduction Emission of EN55022 Class A
Vin = Vin(nom), Full Load

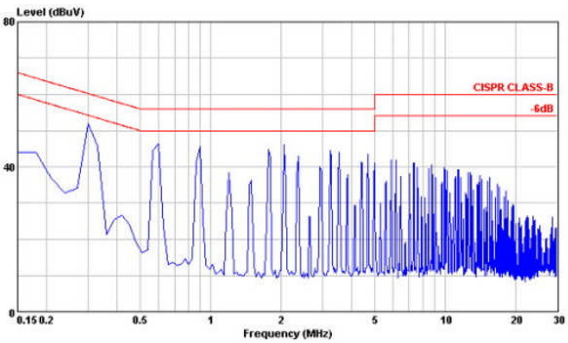

Conduction Emission of EN55022 Class B
Vin = Vin(nom), Full Load

Characteristic Curves (Continued)

All test conditions are at 25°C. The figures are for PXF40-48WD15

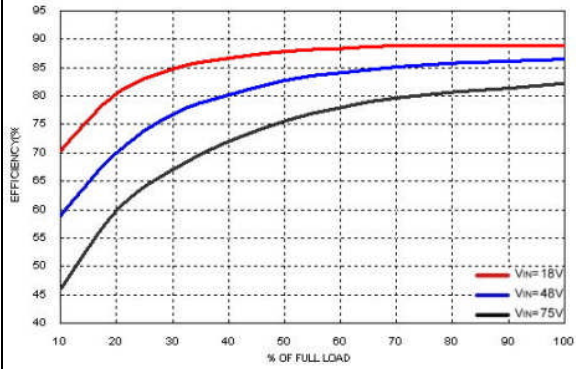

Efficiency Versus Output Current

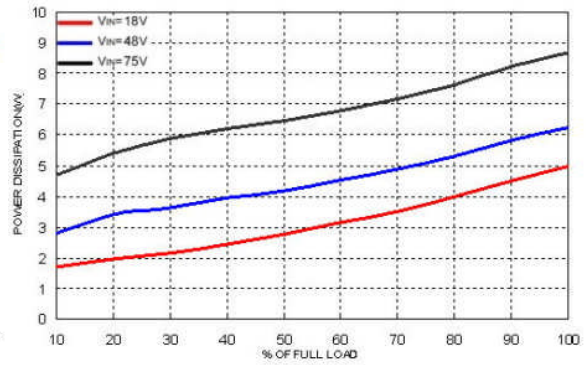

Power Dissipation Versus Output Current

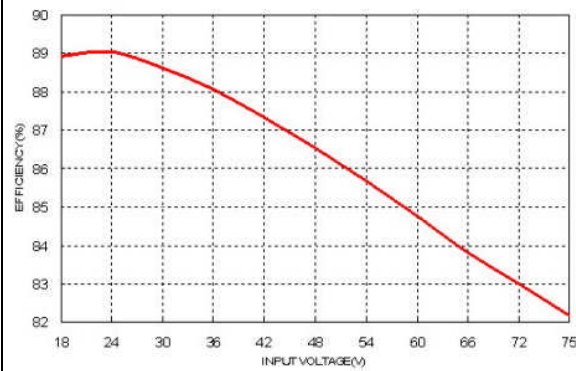

Efficiency Versus Input Voltage. Full Load

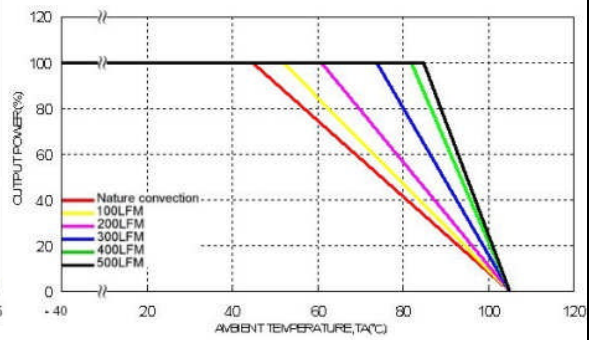

Derating Output Current Versus Ambient Temperature and Airflow Vin = Vin(nom)

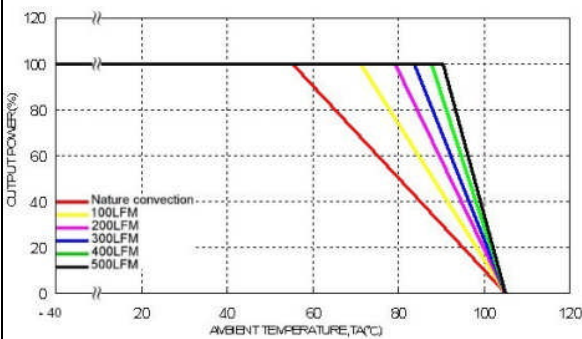

Derating Output Current Versus Ambient Temperature with Heat-Sink and Airflow, Vin = Vin(nom)

Characteristic Curves (Continued)

All test conditions are at 25°C. The figures are for PXF40-48WD15

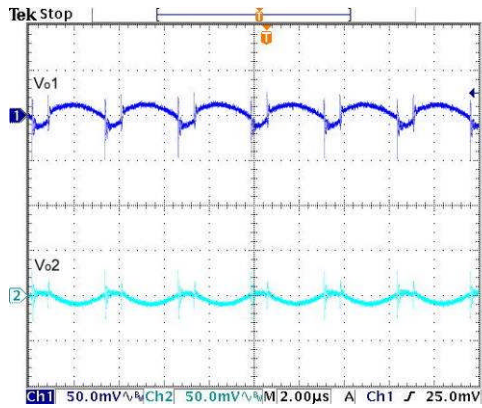

Typical Output Ripple and Noise.
Vin = Vin(nom), Full Load

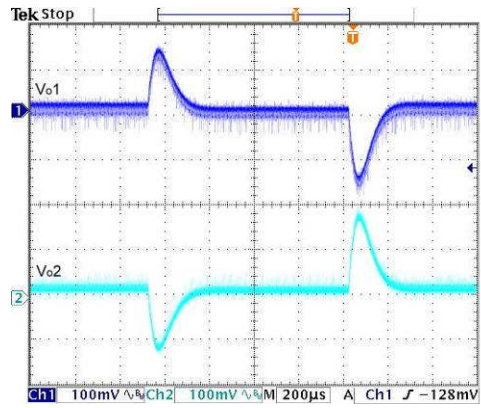

Transient Response to Dynamic Load Change from 100% to 75% to 100% of Full Load ; Vin = Vin(nom)

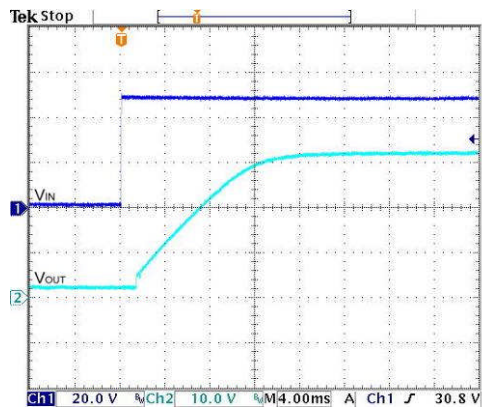

Typical Input Start-Up and Output Rise Characteristic
Vin = Vin(nom), Full Load

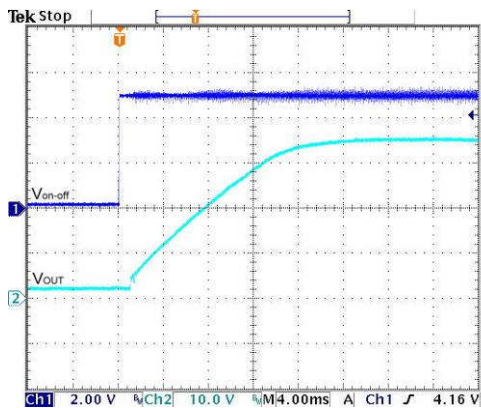

Using ON/OFF Voltage Start-Up and Vo Rise Characteristic
Vin = Vin(nom), Full Load

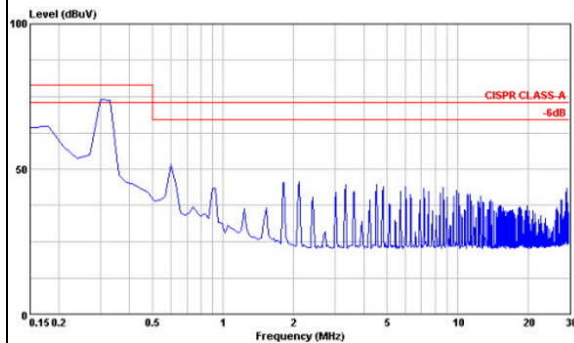

Conduction Emission of EN55022 Class A
Vin = Vin(nom), Full Load

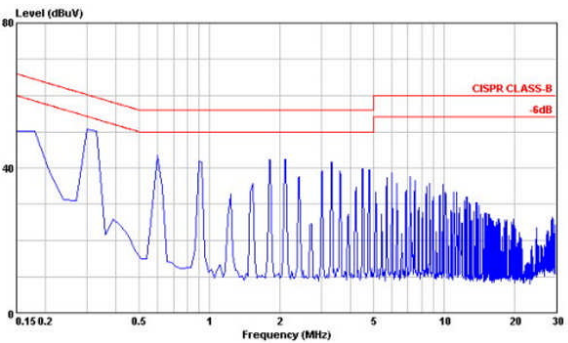

Conduction Emission of EN55022 Class B
Vin = Vin(nom), Full Load

Test Configurations

Input reflected-ripple current measurement test:

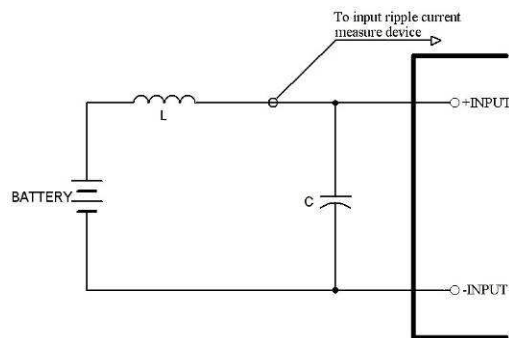

Component	Value	Voltage	Reference
L	12μH	---	---
C	47μF	100V	Aluminum Electrolytic Capacitor

Peak-to-peak output ripple & noise measurement test:

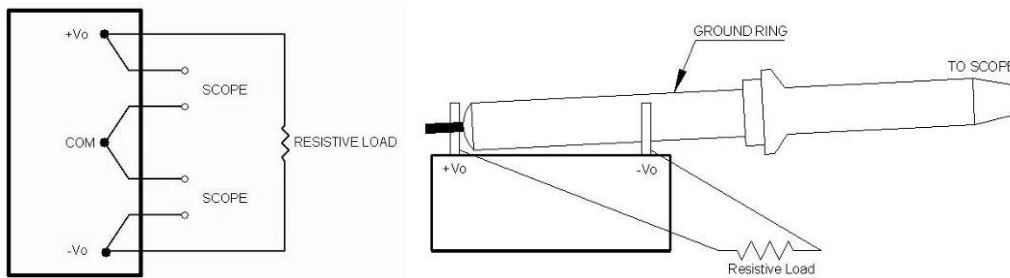

Output voltage and efficiency measurement test:

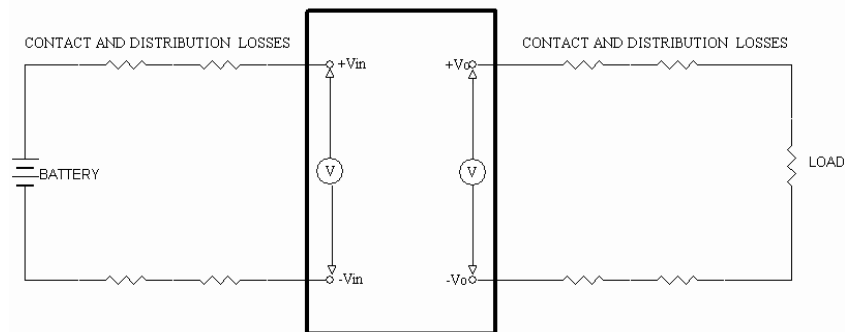

Note: All measurements are taken at the module terminals.

$$Efficiency = \left(\frac{V_o \times I_o}{V_{in} \times I_{in}} \right) \times 100\%$$

EMC Considerations

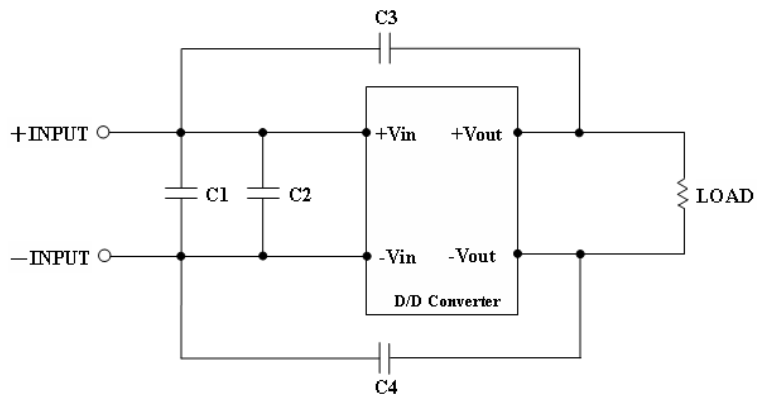

Suggested Schematic for EN55022 Conducted Emissions Class A Limits

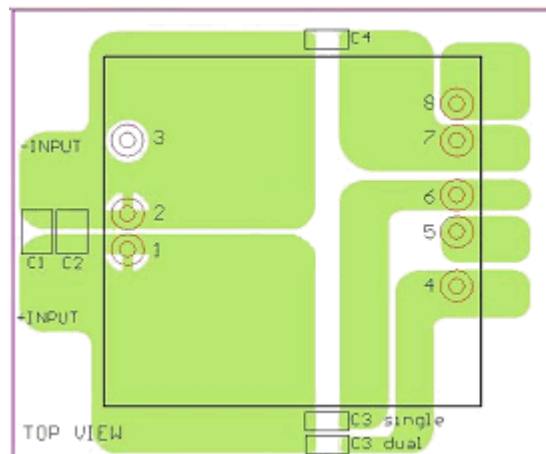

Recommended Layout with Input Filter

To meet conducted emissions EN55022 CLASS A needed the following components :

PXF40-24WDxx

Component	Value	Voltage	Reference
C1,C2	---	---	---
C3,C4	1000pF	2KV	1206 MLCC

PXF40-48WDxx

Component	Value	Voltage	Reference
C1,C2	2.2uF	100V	1812 MLCC
C3,C4	1000pF	2KV	1206 MLCC

EMC Considerations (Continued)

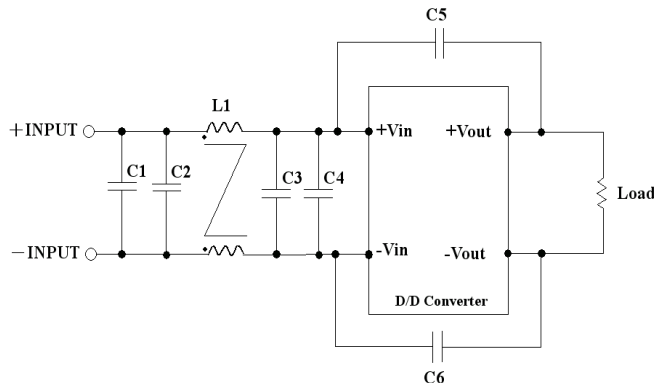

Suggested Schematic for EN55022 Conducted Emissions Class B Limits

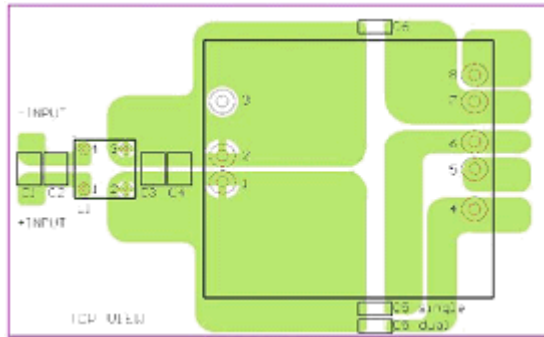

Recommended Layout with Input Filter

To meet conducted emissions EN55022 CLASS B needed the following components :

PXF40-24WDxx

Component	Value	Voltage	Reference
C1,C3	4.7uF	50V	1812 MLCC
C5,C6	1000pF	2KV	1206 MLCC
L1	450uH	----	Common Choke

PXF40-48WDxx

Component	Value	Voltage	Reference
C1,C2	2.2uF	100V	1812 MLCC
C3,C4	2.2uF	100V	1812 MLCC
C5,C6	1000pF	2KV	1206 MLCC
L1	830uH	----	Common Choke

This Common Choke L1 is defined as follows:

- L: 450 μ H \pm 35% / DCR: 25m Ω , max
A height : 9.8 mm, Max
- L: 830 μ H \pm 35% / DCR: 31m Ω , max
A height : 8.8 mm, Max
- Test condition: 100KHz / 100mV
- Recommended through hole; Φ 0.8mm
- All dimensions in millimeters

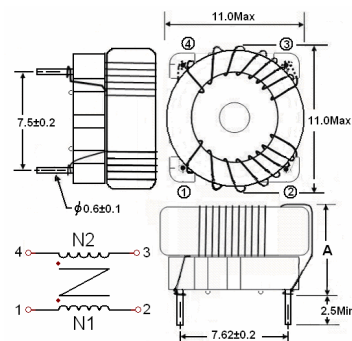

Input Source Impedance

The converter should be connected to a low impedance input source. Highly inductive source impedance can affect the stability of the converter. Input external L-C filter is recommended to minimize input reflected ripple current. The inductor has a simulated source impedance of 12 μ H and the capacitor is Nippon chemi-con KZE series 47 μ F/100V. The capacitor must be located as close as possible to the input terminals of the converter for lower impedance.

Output Over Current Protection

When excessive output currents occur in the system, circuit protection is required on all converters. Normally, overload current is maintained at approximately 150 percent of rated current for PXF40-xxWDxx series.

Hiccup-mode is a method of operation in the converter whose purpose is to protect the converter from being damaged during an over-current fault condition. It also enables the converter to restart when the fault is removed.

One of the problems resulting from over current is that excessive heat may be generated in power devices; especially MOSFET and Schottky diodes and the temperature of those devices may exceed their specified limits. A protection mechanism has to be used to prevent those power devices from being damaged.

Output Over Voltage Protection

The output over-voltage protection consists of an output Zener diode that monitors the voltage on the output terminals. If the voltage on the output terminals exceeds the over-voltage protection threshold, then the Zener diode clamps the output voltage.

Thermal Consideration

The converter operates in a variety of thermal environments. However, sufficient cooling should be provided to help ensure reliable operation of the unit. Heat is removed by conduction, convection, and radiation to the surrounding environment. Proper cooling can be verified by measuring the point as shown in the figure below. The temperature at this location should not exceed 105°C. When operating, adequate cooling must be provided to maintain the test point temperature at or below 105°C. Although the maximum point temperature of the converter is 105°C, limiting this temperature to a lower value will increase the reliability of the unit.

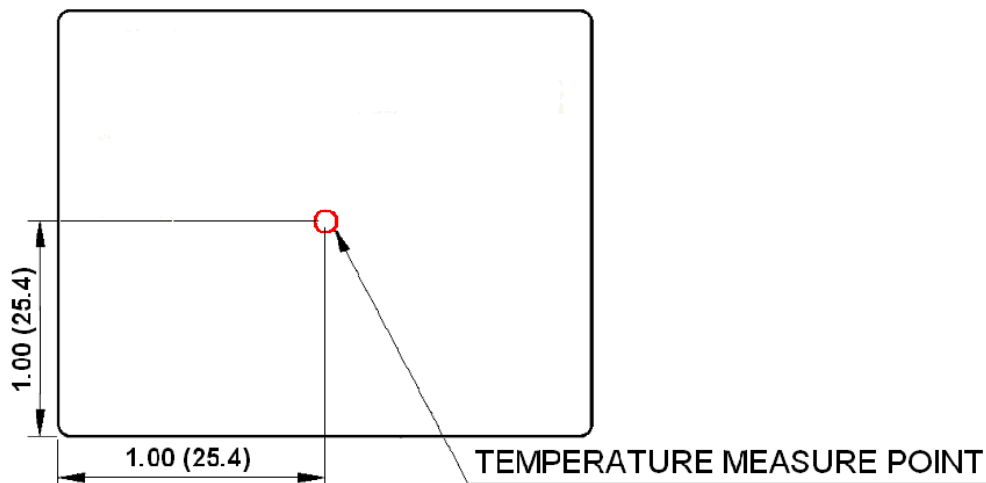

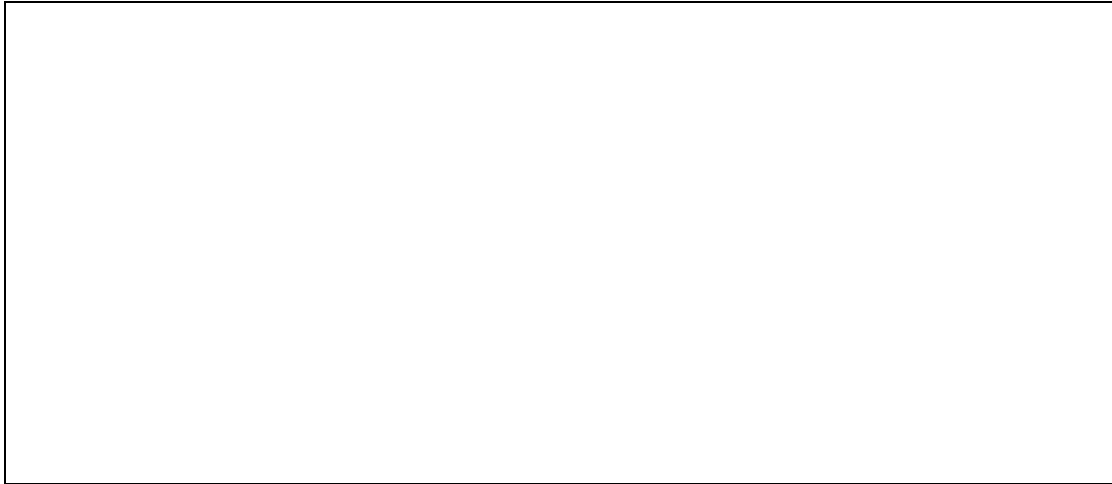

Heat Sink Consideration

Use heat-sink (7G-0026A) for lowering temperature; thus increasing the reliability of the converter.

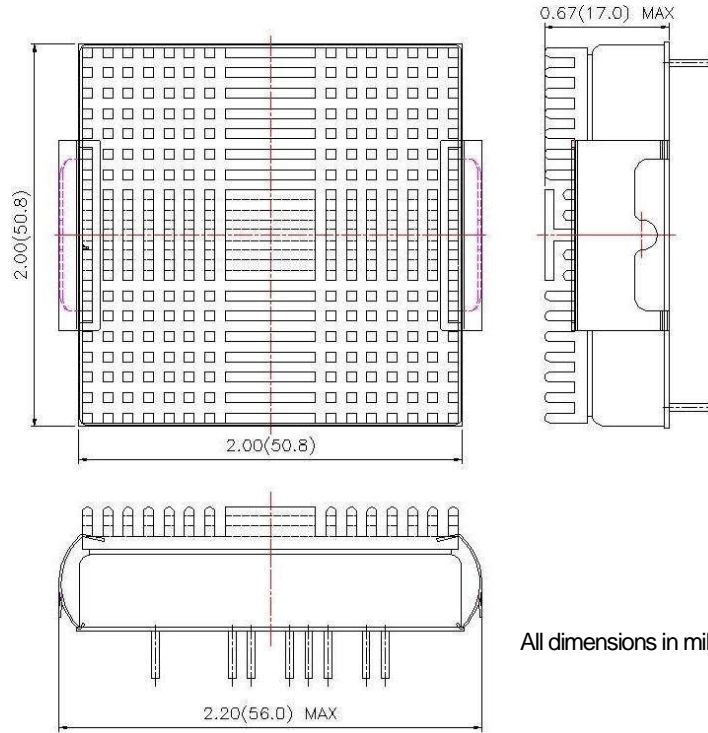

All dimensions in millimeters

Remote ON/OFF Control

The Remote ON/OFF Pin is used to turn the converter on and off. The user must use a switch to control the logic voltage (high or low level) of the pin referenced to $V_i (-)$. The switch can be an open collector transistor, FET or Opto-Coupler. The switch must be capable of sinking up to 0.5 mA at low-level logic voltage. Using High-level logic, the maximum allowable leakage current of the switch at 12V is 0.5 mA.

Remote ON/OFF Implementation Circuits

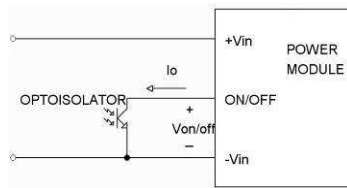

Isolated-Closure Remote ON/OFF

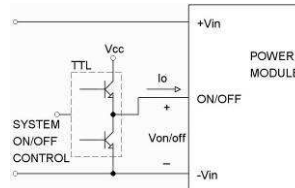

Level Control Using TTL Output

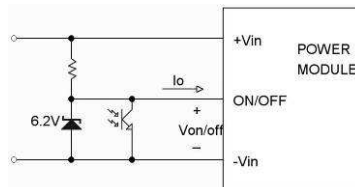

Level Control Using Line Voltage

There are two remote control options available, positive logic and negative logic.

a. Positive logic:

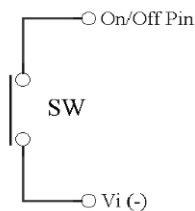

Module is turned off using Low-level logic

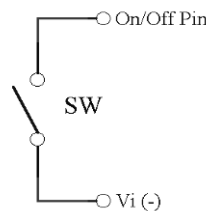

Module is turned on using High-level logic

b. Negative logic:

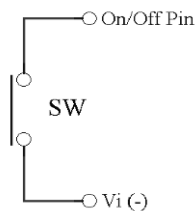

Module is turned on using Low-level logic

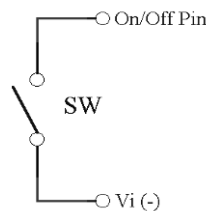

Module is turned off using High-level logic

Mechanical Data

1. All dimensions in Inches (mm)
 Tolerance: X.XX±0.02 (X.X±0.5)
 X.XXX±0.01 (X.XX±0.25)

2. Pin pitch tolerance ±0.01 (0.25)

3. Pin dimension tolerance ±0.004 (0.1)

PIN CONNECTION	
PIN	FUNCTION
1	+INPUT
2	-INPUT
3	CTRL
4	+OUTPUT
5	COM
6	COM
7	-OUTPUT
8	TRIM

EXTERNAL OUTPUT TRIMMING

Output can be externally trimmed by using the method shown below.

TRIM UP

TRIM DOWN

Recommended Pad Layout

Recommended Pad Layout
 ALL Dimensions in inches (millimeters)
 Tolerances:xx.xxx in ±0.010 in (xx.xx mm±0.25mm)

PAD SIZE (LEAD FREE RECOMMENDED)
 PIN THROUGH HOLE: ϕ 0.047in(1.2mm)
 TOP VIEW PAD: ϕ 0.079in(2.0mm)
 BOTTOM VIEW PAD: ϕ 0.118in(3.0mm)

Output Voltage Adjustment

Output voltage set point adjustment allows the user to increase or decrease the output voltage set point of a converter. This is accomplished by connecting an external resistor between the TRIM pin and either the Vo(+) or Vo(-) pins. With an external resistor between the TRIM and Vo(-) pin, the output voltage set point increases. With an external resistor between the TRIM and Vo(+) pin, the output voltage set point decreases.

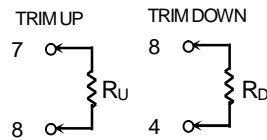

TRIM TABLE

PXF40-xxWD12

Trim up (%)	1	2	3	4	5	6	7	8	9	10
V _{OUT} (Volts)=	±12.12	±12.24	±12.36	±12.48	±12.6	±12.72	±12.84	±12.96	±13.08	±13.2
R _U (K Ohms)=	218.21	98.105	58.07	38.052	26.042	18.035	12.316	8.026	4.69	2.021
Trim down (%)	1	2	3	4	5	6	7	8	9	10
V _{OUT} (Volts)=	±11.88	±11.76	±11.64	±11.52	±11.4	±11.28	±11.16	±11.04	±10.92	±10.8
R _D (K Ohms)=	273.44	123.02	72.874	47.803	32.76	22.732	15.568	10.196	6.017	2.675

PXF40-xxWD15

Trim up (%)	1	2	3	4	5	6	7	8	9	10
V _{OUT} (Volts)=	±15.15	±15.3	±15.45	±15.6	±15.75	±15.9	±16.05	±16.2	±16.35	±16.5
R _U (K Ohms)=	268.29	120.64	71.429	46.822	32.058	22.215	15.184	9.911	5.81	2.529
Trim down (%)	1	2	3	4	5	6	7	8	9	10
V _{OUT} (Volts)=	±14.85	±14.7	±14.55	±14.4	±14.25	±14.1	±13.95	±13.8	±13.65	±13.5
R _D (K Ohms)=	337.71	152.02	90.126	59.178	40.609	28.23	19.387	12.756	7.598	3.471

Soldering Consideration

Lead free wave solder profile for PXF40-xxWDxx -SERIES

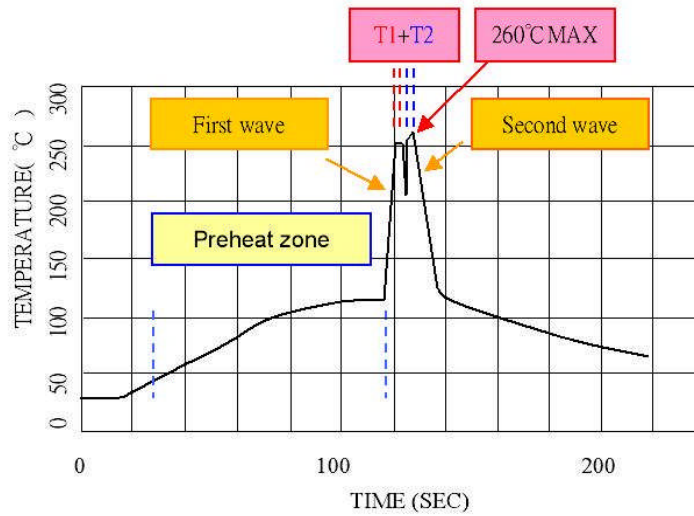

Zone	Reference Parameter
Preheat zone	Rise temp. speed : 3°C / sec max. Preheat temp. : 100~130°C
Actual heating	Peak temp. : 250~260°C Peak time (T1+T2 time) : 4~6 sec

Reference Solder:Sn-Ag-Cu/Sn-Cu

Hand Welding: Soldering iron: Power 90W

Welding Time: 2-4 sec

Temp. 380-400 °C

Packaging Information

10 PCS per TUBE

Part Number Structure

PXF40 - 48 WD 12 - N

Model Number	Input Range	Output Voltage	Output Current Full load	Input Current Full Load ⁽¹⁾	Eff ⁽²⁾ (%)
PXF40-24WD12	9 – 36 VDC	±12 VDC	± 1667mA	2032mA	86
PXF40-24WD15	9 – 36 VDC	±15 VDC	± 1333mA	2032mA	86
PXF40-48WD12	18 – 75 VDC	±12 VDC	± 1667mA	1016mA	86
PXF40-48WD15	18 – 75 VDC	±15 VDC	± 1333mA	1016mA	86

Note 1. Maximum value at nominal input voltage and full load
 Note 2. Typical value at nominal input voltage and full load.

Safety and Installation Instruction

Fusing Consideration

Caution: This power module is not internally fused. An input line fuse must always be used.

This encapsulated converter can be used in a wide variety of applications, ranging from simple stand-alone operation to an integrated part of a sophisticated power architecture. For maximum flexibility, internal fusing is not included; however, to achieve maximum safety and system protection, always use an input line fuse. The safety agencies require a slow-blow fuse with maximum rating of 8A for PXF40-24WDxx modules and 5A for PXF40-48WDxx modules. Based on the information provided in this data sheet on Inrush energy and maximum DC input current; the same type of fuse with lower rating can be used. Refer to the fuse manufacturer's data for further information.

MTBF and Reliability

The MTBF of PXF40-xxWDxx series of DC/DC converters has been calculated using:

Bellcore TR-NWT-000332 Case I: 50% stress, Operating Temperature at 40°C (Ground fixed and controlled environment). The resulting figure for MTBF is 1.105×10⁶ hours.

MIL-HDBK 217F NOTICE 2 FULL LOAD, Operating Temperature at 25°C °C. The resulting figure for MTBF is 1.511×10⁵ hours.