

### FEATURES

- Input voltage range: 3.0 V to 5.5 V
- Three 1800 mA buck regulators
- 24-lead, 4 mm × 4 mm LFCSP package
- Regulator accuracy: ±1.8%
- Factory programmable or external adjustable VOUTx pins
- Precision enables for easier power sequencing
- Power-good pins for monitoring each regulator
- 3 MHz buck operation with forced PWM and auto PWM/PSM modes
- BUCK1/BUCK2/BUCK3: output voltage range from 0.8 V to 3.8 V

### APPLICATIONS

- Power for processors, application specific integrated circuits (ASICs), field-programmable gate arrays (FPGAs), and radio frequency (RF) chipsets
- Portable instrumentation and medical devices
- Space constrained devices

### TYPICAL APPLICATION CIRCUIT

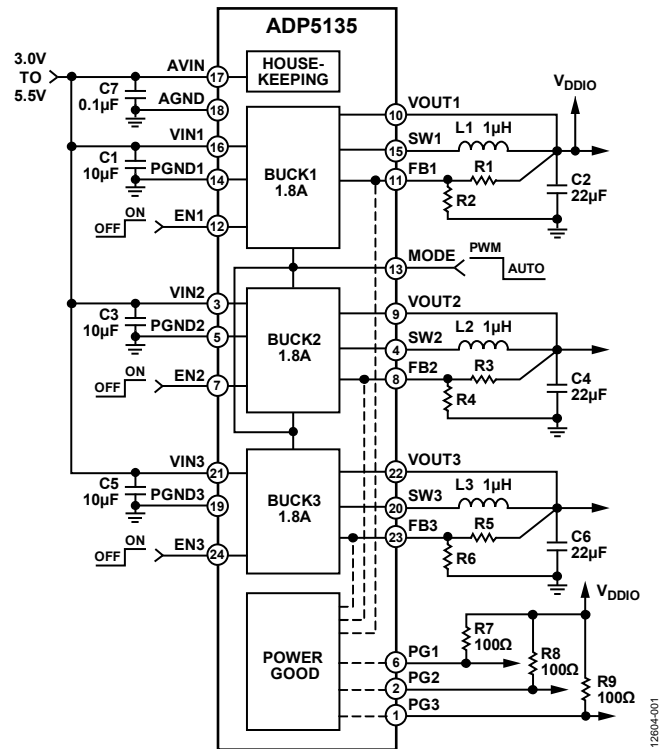

Figure 1.

### GENERAL DESCRIPTION

The ADP5135 combines three high performance buck regulators (BUCK1, BUCK2, and BUCK3). It is available in a 24-lead, 4 mm × 4 mm LFCSP.

The high switching frequency of the buck regulators enables tiny multilayer external components and minimizes the board space. When the MODE pin is set to high, the buck regulators operate in forced pulse-width modulation (PWM) mode. When the MODE pin is set to low, the buck regulators operate in PWM mode only when the load is above a predefined threshold. When the load current falls below this predefined threshold, the regulator operates in power save mode (PSM), improving the light load efficiency.

BUCK1 and BUCK2 operate in synchronization, and BUCK3 operates out of phase to reduce the input capacitor requirement.

Regulators in the ADP5135 are activated through dedicated enable pins. The default output voltages can be externally set in the adjustable version, or factory programmable to a wide range of preset values in the fixed voltage version.

Table 1. Family Devices

Device	Channels	Max Current	Package
ADP5023	2 buck regulators, 1 LDO	800 mA, 300 mA	LFCSP (CP-24-10)
ADP5024	2 buck regulators, 1 LDO	1.2 A, 300 mA	LFCSP (CP-24-10)
ADP5034	2 buck regulators, 2 LDOs	1.2 A, 300 mA	LFCSP (CP-24-10), TSSOP (RE-28-1)
ADP5037	2 buck regulators, 2 LDOs	800 mA, 300 mA	LFCSP (CP-24-10)
ADP5033	2 buck regulators, 2 LDOs with 2 ENx pins	800 mA, 300 mA	WLCSP (CB-16-8)
ADP5040	1 buck regulator, 2 LDOs	1.2 A, 300 mA	LFCSP (CP-20-10)
ADP5041	1 buck regulator, 2 LDOs with supervisory circuit, watchdog function, and manual reset	1.2 A, 300 mA	LFCSP (CP-20-10)
ADP5133	2 buck regulators with 2 ENx pins	800 mA	WLCSP (CB-16-8)
ADP5134	2 buck regulators, 2 LDOs with precision enable and power good	1.2 A, 300 mA	LFCSP (CP-24-7)

Rev. 0

[Document Feedback](#)

Information furnished by Analog Devices is believed to be accurate and reliable. However, no responsibility is assumed by Analog Devices for its use, nor for any infringements of patents or other rights of third parties that may result from its use. Specifications subject to change without notice. No license is granted by implication or otherwise under any patent or patent rights of Analog Devices. Trademarks and registered trademarks are the property of their respective owners.

# ADP5135\* PRODUCT PAGE QUICK LINKS

Last Content Update: 02/23/2017

---

## COMPARABLE PARTS

View a parametric search of comparable parts.

## EVALUATION KITS

- ADP5135 Evaluation Board

## DOCUMENTATION

### Data Sheet

- ADP5135: Triple 1800 mA Buck Regulators With Precision Enables and Power Good Outputs Data Sheet

### User Guides

- UG-765: Evaluating the ADP5135 Micropower Management Unit

## TOOLS AND SIMULATIONS

- 5V uPMU BuckDesigner
- ADIsimPower™ Voltage Regulator Design Tool

## DESIGN RESOURCES

- ADP5135 Material Declaration
- PCN-PDN Information
- Quality And Reliability
- Symbols and Footprints

## DISCUSSIONS

View all ADP5135 EngineerZone Discussions.

## SAMPLE AND BUY

Visit the product page to see pricing options.

## TECHNICAL SUPPORT

Submit a technical question or find your regional support number.

## DOCUMENT FEEDBACK

Submit feedback for this data sheet.

---

## TABLE OF CONTENTS

Features .....	1	Theory of Operation .....	13
Applications.....	1	Power Management Unit.....	13
Typical Application Circuit .....	1	Buck Regulators: BUCK1, BUCK2, AND BUCK3 .....	15
General Description .....	1	Applications Information .....	17
Revision History .....	2	Buck External Component Selection.....	17
Specifications.....	3	Typical Application Schematics.....	19
BUCK1, BUCK2, and BUCK3.....	4	Power Dissipation and Thermal Considerations .....	21
Input and Output Capacitors, Recommended .....	4	Buck Regulator Power Dissipation .....	21
Absolute Maximum Ratings.....	5	Junction Temperature .....	22
Thermal Resistance .....	5	PCB Layout Guidelines.....	23
ESD Caution.....	5	Outline Dimensions .....	24
Pin Configuration and Function Descriptions.....	6	Ordering Guide .....	24
Typical Performance Characteristics .....	7		

## REVISION HISTORY

11/14—Revision 0: Initial Version

## SPECIFICATIONS

$V_{AVIN} = V_{IN1} = V_{IN2} = V_{IN3} = 3.0\text{ V to }5.5\text{ V}$ ;  $T_J = -40^\circ\text{C to }+125^\circ\text{C}$  for minimum/maximum specifications, and  $T_A = 25^\circ\text{C}$  for typical specifications, unless otherwise noted.

**Table 2.**

Parameter	Symbol	Test Conditions/Comments	Min	Typ	Max	Unit
INPUT VOLTAGE RANGE	$V_{AVIN}, V_{IN1}, V_{IN2}, V_{IN3}$		3.0		5.5	V
THERMAL SHUTDOWN						
Threshold	$T_{SD}$	$T_J$ rising		150		$^\circ\text{C}$
Hysteresis	$T_{SD\_HYS}$			20		$^\circ\text{C}$
START-UP TIME <sup>1</sup>						
BUCK1	$t_{START1}$			450		$\mu\text{s}$
BUCK2	$t_{START2}$			550		$\mu\text{s}$
BUCK3	$t_{START3}$			550		$\mu\text{s}$
START-UP TIME, BUCK3 FIRST						
BUCK3	$t_{START4}$			550		$\mu\text{s}$
BUCK1	$t_{START5}$			200		$\mu\text{s}$
BUCK2	$t_{START6}$			300		$\mu\text{s}$
SHUTDOWN CONTROL		All ENx pins below $V_{IL\_EN}$ level to achieve $I_{SHUTDOWN}$				
Level High	$V_{IH\_EN}$		0.9			V
Level Low	$V_{IL\_EN}$				0.35	V
PRECISION ENABLE PINS		Regulator activation/deactivation thresholds				
Analog Activation Threshold	$V_{ENR}$	Device out of shutdown ( $V_{ENx} > V_{IH\_EN}$ )	0.94	0.97	1	V
Hysteresis (Regulator Deactivation)	$V_{ENH}$			80		mV
Input Leakage Current	$V_{I\_LEAKAGE}$			0.05	1	$\mu\text{A}$
POWER-GOOD PINS		Monitors $V_{OUT}$ falling out of regulation				
Falling Threshold	$V_{PGLOW}$			85		% $V_{OUT}$
Rising Threshold	$V_{PGHYS}$		91	94	97	% $V_{OUT}$
Delay	$t_{PGDLY}$			20		$\mu\text{s}$
Leakage Current	$I_{PGIQ}$	$V_{PG} = V_{IN}$			1	$\mu\text{A}$
Output Voltage Low	$V_{PGOL}$	Load current = 1 mA		0.02	0.15	V
MODE PIN						
Level High	$V_{IH\_MOD}$		1.1			V
Level Low	$V_{IL\_MOD}$				0.4	V
INPUT CURRENT		No load, no buck switching				
All Channels Enabled	$I_{STBY\_NOSW}$			85	110	$\mu\text{A}$
All Channels Disabled	$I_{SHUTDOWN}$	$T_J = -40^\circ\text{C to }+85^\circ\text{C}$		0.3	1.5	$\mu\text{A}$
AVIN UNDERVOLTAGE LOCKOUT						
Mid UVLO Input Voltage Rising	$UVLO_{AVINRISE}$				2.95	V
Mid UVLO Input Voltage Falling	$UVLO_{AVINFALL}$		2.45			V

<sup>1</sup> Start-up time is defined as the time from  $EN1 = EN2 = EN3$  at 0 V to  $V_{AVIN}$  to  $V_{OUT1}$ ,  $V_{OUT2}$ , and  $V_{OUT3}$  reaching 90% of their nominal level. Start-up times are shorter for individual channels if another channel is already enabled. See the Typical Performance Characteristics section for more information.

**BUCK1, BUCK2, AND BUCK3**

$V_{AVIN} = V_{IN1} = V_{IN2} = V_{IN3} = 3.0 \text{ V to } 5.5 \text{ V}$ ;  $T_j = -40^\circ\text{C to } +125^\circ\text{C}$  for minimum/maximum specifications, and  $T_A = 25^\circ\text{C}$  for typical specifications, unless otherwise noted.<sup>1</sup>

**Table 3.**

Parameter	Symbol	Test Conditions/Comments	Min	Typ	Max	Unit
<b>OUTPUT CHARACTERISTICS</b>						
Output Voltage Accuracy	$\Delta V_{OUT1}/V_{OUT1}, \Delta V_{OUT2}/V_{OUT2}, \Delta V_{OUT3}/V_{OUT3}$	PWM mode; $I_{LOAD1} = I_{LOAD2} = I_{LOAD3} = 0 \text{ mA}$	-1.8		+1.8	%
Line Regulation	$(\Delta V_{OUT1}/V_{OUT1})/\Delta V_{IN1}, (\Delta V_{OUT2}/V_{OUT2})/\Delta V_{IN2}, (\Delta V_{OUT3}/V_{OUT3})/\Delta V_{IN3}$	PWM mode		-0.05		%/V
Load Regulation	$(\Delta V_{OUT1}/V_{OUT1})/\Delta I_{OUT1}, (\Delta V_{OUT2}/V_{OUT2})/\Delta I_{OUT2}, (\Delta V_{OUT3}/V_{OUT3})/\Delta I_{OUT3}$	$I_{LOAD} = 0 \text{ mA to } 1800 \text{ mA}$ , PWM mode		-0.1		%/A
<b>VOLTAGE FEEDBACK</b>	$V_{FB1}, V_{FB2}$	Models with adjustable outputs	0.491	0.5	0.509	V
<b>OPERATING SUPPLY CURRENT</b>						
BUCK1 Only	$I_{IN1}$	MODE = ground $I_{LOAD1} = 0 \text{ mA}$ , device not switching, all other channels disabled		42		$\mu\text{A}$
BUCK2 Only	$I_{IN2}$	$I_{LOAD2} = 0 \text{ mA}$ , device not switching, all other channels disabled		52		$\mu\text{A}$
BUCK3 Only	$I_{IN3}$	$I_{LOAD3} = 0 \text{ mA}$ , device not switching, all other channels disabled		52		$\mu\text{A}$
BUCK1, BUCK2, and BUCK3	$I_{IN}$	$I_{LOAD1} = I_{LOAD2} = I_{LOAD3} = 0 \text{ mA}$ , device not switching		85		$\mu\text{A}$
<b>PSM CURRENT THRESHOLD</b>	$I_{PSM}$	PSM to PWM operation		100		mA
<b>SWx CHARACTERISTICS</b>						
SWx On Resistance	$R_{NFET}$ $R_{PFET}$	$V_{IN1} = V_{IN2} = V_{IN3} = 3.6 \text{ V}$		140	225	m $\Omega$
	$R_{NFET}$ $R_{PFET}$	$V_{IN1} = V_{IN2} = V_{IN3} = 5.5 \text{ V}$		122	189	m $\Omega$
Current Limit	$I_{LIMIT1}, I_{LIMIT2}, I_{LIMIT3}$	Positive channel field effect transistor (PFET) switch peak current limit	2250	2600	2950	mA
<b>ACTIVE PULL-DOWN RESISTANCE</b>	$R_{PVDN}$	$V_{IN1} = V_{IN2} = V_{IN3} = 3.6 \text{ V}$ ; channel disabled		75		$\Omega$
<b>OSCILLATOR FREQUENCY</b>	$f_{SW}$		2.5	3.0	3.5	MHz

<sup>1</sup> All limits at temperature extremes are guaranteed via correlation using standard statistical quality control (SQC).

**INPUT AND OUTPUT CAPACITORS, RECOMMENDED**

$T_A = -40^\circ\text{C to } +125^\circ\text{C}$ , unless otherwise specified.

**Table 4.**

Parameter	Symbol	Min	Typ	Max	Unit
<b>NOMINAL INPUT AND OUTPUT CAPACITOR RATINGS</b>					
BUCK1, BUCK2, and BUCK3					
Input Capacitor Ratings	$C_{MIN1}, C_{MIN2}, C_{MIN3}$	4.7		40	$\mu\text{F}$
Output Capacitor Ratings	$C_{MIN4}, C_{MIN5}, C_{MIN6}$	10		40	$\mu\text{F}$
<b>CAPACITOR ESR</b>	$R_{ESR}$	0.001		1	$\Omega$

## ABSOLUTE MAXIMUM RATINGS

Table 5.

Parameter	Rating
AVIN to AGND	-0.3 V to +6 V
VIN1, VIN2, VIN3 to AVIN	-0.3 V to +0.3 V
PGND1, PGND2, PGND3 to AGND	-0.3 V to +0.3 V
VOUT1, VOUT2, VOUT3, FB1, FB2, FB3, EN1, EN2, EN3, MODE, PG1, PG2, PG3 to AGND	-0.3 V to (AVIN + 0.3 V)
SW1 to PGND1	-0.3 V to (VIN1 + 0.3 V)
SW2 to PGND2	-0.3 V to (VIN2 + 0.3 V)
SW3 to PGND3	-0.3 V to (VIN3 + 0.3 V)
Storage Temperature Range	-65°C to +150°C
Operating Junction Temperature Range	-40°C to +125°C
Soldering Conditions	JEDEC J-STD-020

Stresses at or above those listed under Absolute Maximum Ratings may cause permanent damage to the product. This is a stress rating only; functional operation of the product at these or any other conditions above those indicated in the operational section of this specification is not implied. Operation beyond the maximum operating conditions for extended periods may affect product reliability.

For detailed information on power dissipation, see the Power Dissipation and Thermal Considerations section.

## THERMAL RESISTANCE

$\theta_{JA}$  is specified for the worst-case conditions, that is, a device soldered in a circuit board for surface-mount packages.

Table 6. Thermal Resistance

Package Type	$\theta_{JA}$	$\theta_{JC}$	Unit
24-Lead LFCSP	35	3	°C/W

## ESD CAUTION



**ESD (electrostatic discharge) sensitive device.** Charged devices and circuit boards can discharge without detection. Although this product features patented or proprietary protection circuitry, damage may occur on devices subjected to high energy ESD. Therefore, proper ESD precautions should be taken to avoid performance degradation or loss of functionality.

## PIN CONFIGURATION AND FUNCTION DESCRIPTIONS

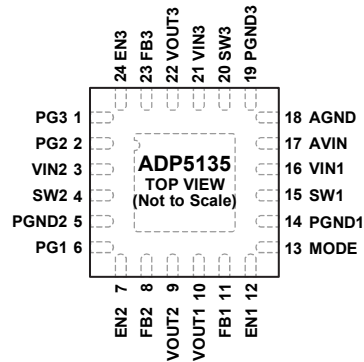

### NOTES

1. SOLDER THE EXPOSED PAD TO THE GROUND PLANE WITH SEVERAL VIAS.

12604-002

Figure 2. Pin Configuration—View from the Top of the Die

Table 7. Pin Function Descriptions

Pin No.	Mnemonic	Description
1	PG3	Open-Drain Power-Good Output to Monitor the Output Voltage of BUCK3.
2	PG2	Open-Drain Power-Good Output to Monitor the Output Voltage of BUCK2.
3	VIN2	BUCK2 Input Supply (3.0 V to 5.5 V). Connect VIN2 to VIN1, VIN3, and AVIN.
4	SW2	BUCK2 Switching Node.
5	PGND2	Dedicated Power Ground for BUCK2.
6	PG1	Open-Drain Power-Good Output to Monitor the Output Voltage of BUCK1.
7	EN2	BUCK2 Enable. A high level turns on this regulator, and a low level turns it off.
8	FB2	BUCK2 Feedback Input. For device models with an adjustable output voltage, connect this pin to the middle of the BUCK2 resistor divider. For device models with a fixed output voltage, leave this pin unconnected.
9	VOUT2	BUCK2 Output Voltage Sensing Input. Connect VOUT2 to the top of the capacitor on VOUT2.
10	VOUT1	BUCK1 Output Voltage Sensing Input. Connect VOUT1 to the top of the capacitor on VOUT1.
11	FB1	BUCK1 Feedback Input. For device models with an adjustable output voltage, connect this pin to the middle of the BUCK1 resistor divider. For device models with a fixed output voltage, leave this pin unconnected.
12	EN1	BUCK1 Enable. A high level turns on this regulator, and a low level turns it off.
13	MODE	BUCK1/BUCK2 Operating Mode. MODE = high: forced PWM operation. MODE = low: auto PWM/PSM operation.
14	PGND1	Dedicated Power Ground for BUCK1.
15	SW1	BUCK1 Switching Node.
16	VIN1	BUCK1 Input Supply (3.0 V to 5.5 V). Connect VIN1 to VIN2, VIN3, and AVIN.
17	AVIN	Analog Input Supply (3.0 V to 5.5 V). Connect AVIN to VIN1, VIN2, and VIN3.
18	AGND	Analog Ground.
19	PGND3	Dedicated Power Ground for BUCK3.
20	SW3	BUCK3 Switching Node.
21	VIN3	BUCK3 Input Supply (3.0 V to 5.5 V). Connect VIN3 to VIN1, VIN2 and AVIN.
22	VOUT3	BUCK3 Output Voltage Sensing Input. Connect VOUT3 to the top of the capacitor on VOUT3.
23	FB3	BUCK3 Feedback Input. For device models with an adjustable output voltage, connect this pin to the middle of the BUCK3 resistor divider. For device models with a fixed output voltage, leave this pin unconnected.
24	EN3	BUCK3 Enable. A high level turns on this regulator, and a low level turns it off.
	EP	Exposed Pad. Solder the exposed pad to the ground plane.

# TYPICAL PERFORMANCE CHARACTERISTICS

$V_{IN1} = V_{IN2} = V_{IN3} = 3.6\text{ V}$ ,  $T_A = 25^\circ\text{C}$ , unless otherwise noted.

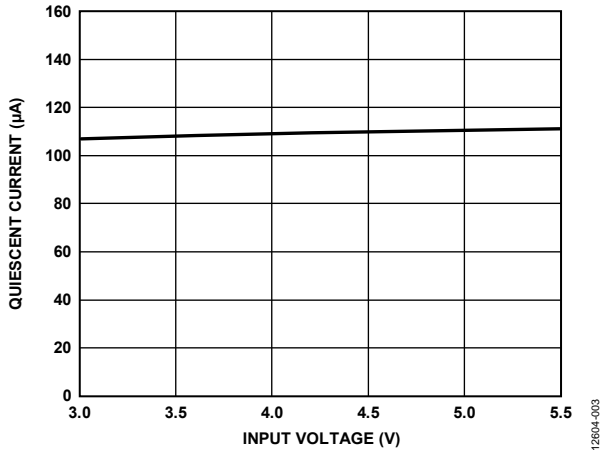

Figure 3. System Quiescent Current vs. Input Voltage,  $V_{OUT1} = 3.3\text{ V}$ ,  $V_{OUT2} = 1.8\text{ V}$ ,  $V_{OUT3} = 1.2\text{ V}$ , All Channels Unloaded

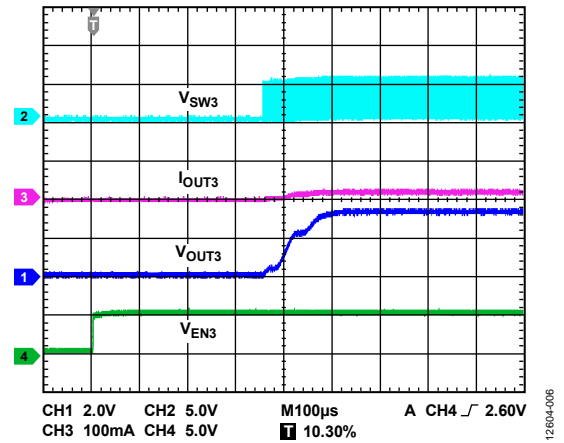

Figure 6. BUCK3 Startup,  $V_{OUT3} = 3.3\text{ V}$ ,  $I_{OUT3} = 20\text{ mA}$

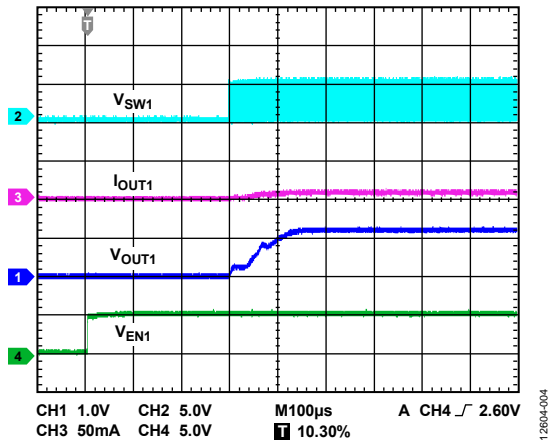

Figure 4. BUCK1 Startup,  $V_{OUT1} = 1.2\text{ V}$ ,  $I_{OUT1} = 10\text{ mA}$

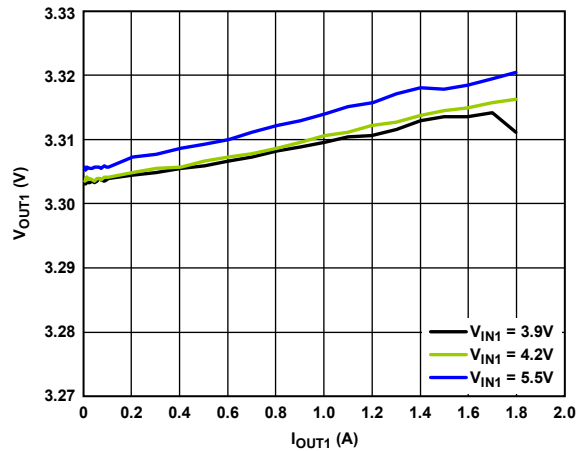

Figure 7. BUCK1 Load Regulation Across Input Voltage,  $V_{OUT1} = 3.3\text{ V}$ , PWM Mode

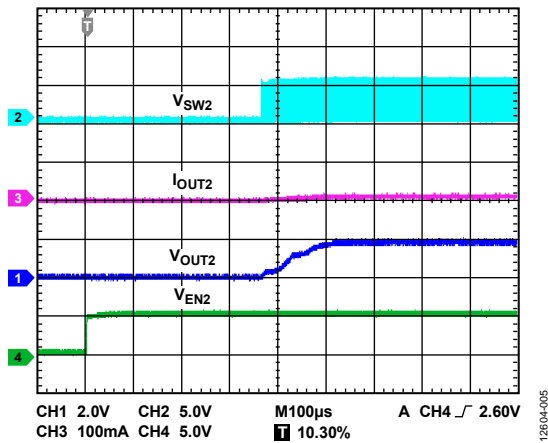

Figure 5. BUCK2 Startup,  $V_{OUT2} = 1.8\text{ V}$ ,  $I_{OUT2} = 10\text{ mA}$

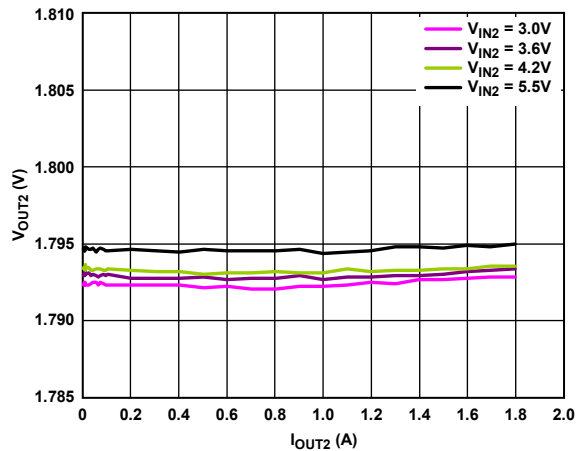

Figure 8. BUCK2 Load Regulation Across Input Voltage,  $V_{OUT2} = 1.8\text{ V}$ , PWM Mode



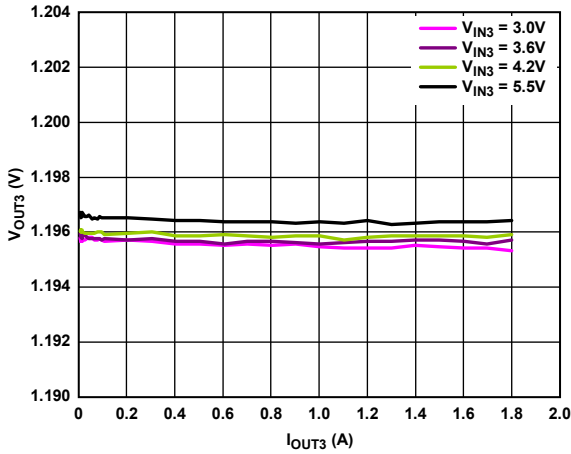

Figure 9. BUCK3 Load Regulation Across Input Voltage,  $V_{OUT3} = 1.2\text{ V}$ , PWM Mode

12804-009

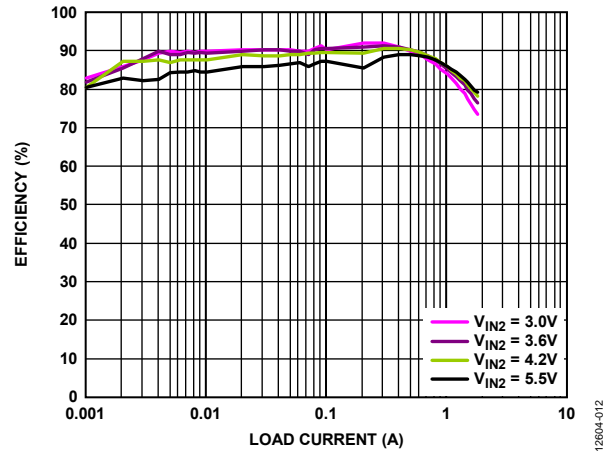

Figure 12. BUCK2 Efficiency vs. Load Current, Across Input Voltage,  $V_{OUT2} = 1.8\text{ V}$ , Auto Mode

12804-012

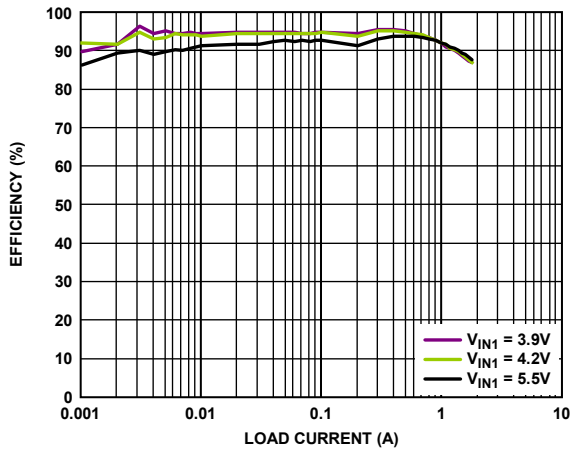

Figure 10. BUCK1 Efficiency vs. Load Current, Across Input Voltage,  $V_{OUT1} = 3.3\text{ V}$ , Auto Mode

12804-010

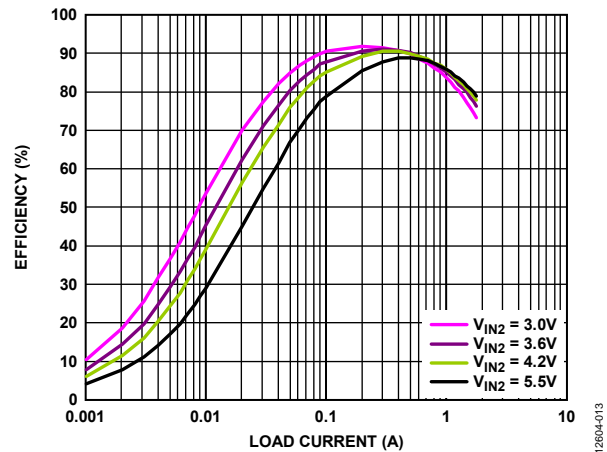

Figure 13. BUCK2 Efficiency vs. Load Current, Across Input Voltage,  $V_{OUT2} = 1.8\text{ V}$ , PWM Mode

12804-013

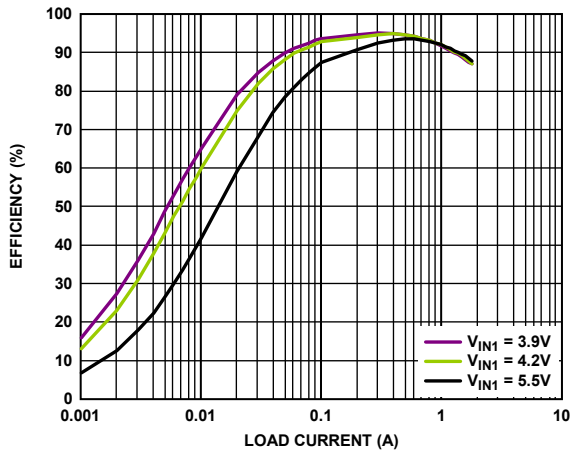

Figure 11. BUCK1 Efficiency vs. Load Current, Across Input Voltage,  $V_{OUT1} = 3.3\text{ V}$ , PWM Mode

12804-011

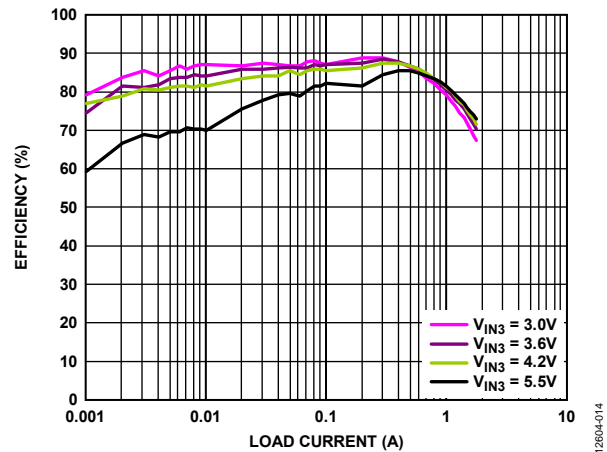

Figure 14. BUCK3 Efficiency vs. Load Current, Across Input Voltage,  $V_{OUT3} = 1.2\text{ V}$ , Auto Mode

12804-014

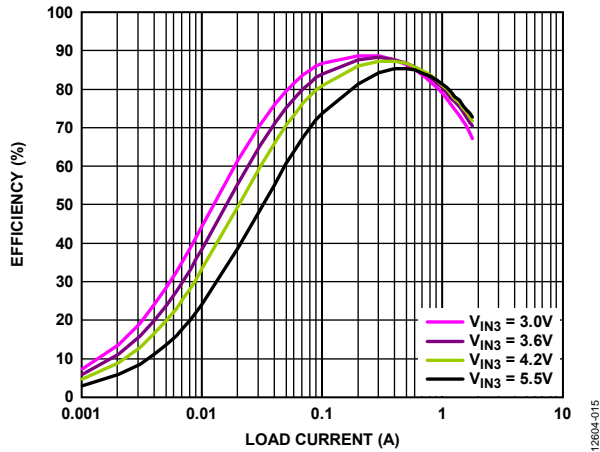

Figure 15. BUCK3 Efficiency vs. Load Current, Across Input Voltage,  $V_{OUT3} = 1.2\text{ V}$ , PWM Mode

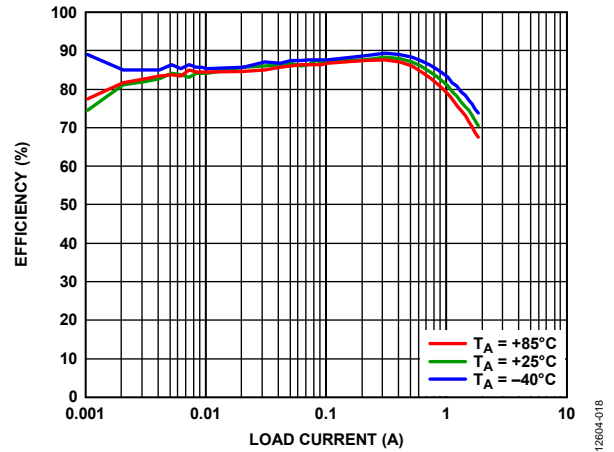

Figure 18. BUCK3 Efficiency vs. Load Current, Across Temperature,  $V_{OUT3} = 1.2\text{ V}$ , Auto Mode

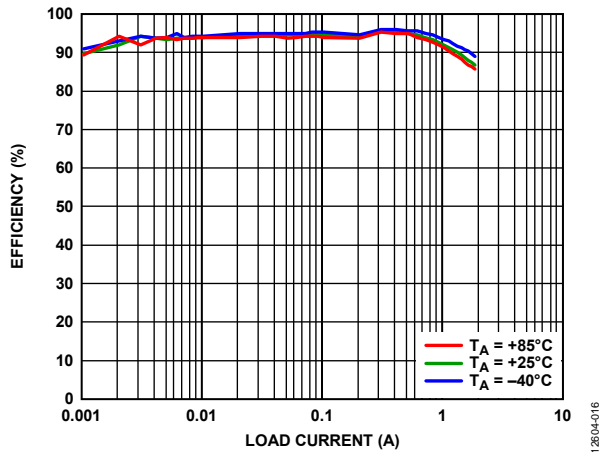

Figure 16. BUCK1 Efficiency vs. Load Current, Across Temperature,  $V_{OUT1} = 3.3\text{ V}$ , Auto Mode

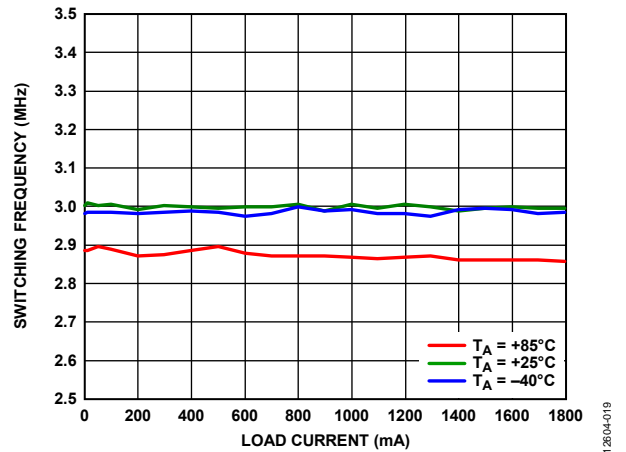

Figure 19. BUCK2 Switching Frequency vs. Load Current, Across Temperature,  $V_{OUT2} = 1.8\text{ V}$ , PWM Mode

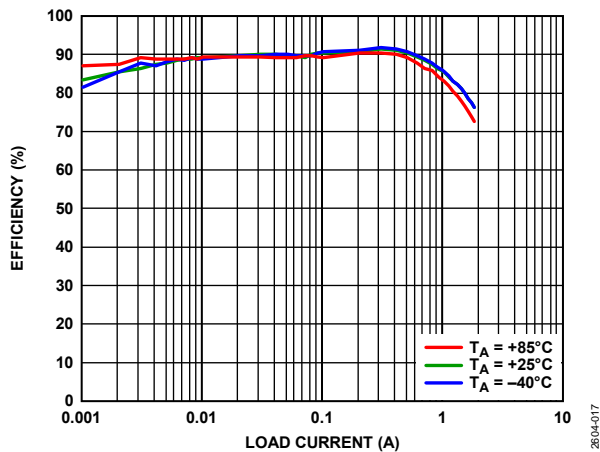

Figure 17. BUCK2 Efficiency vs. Load Current, Across Temperature,  $V_{OUT2} = 1.8\text{ V}$ , Auto Mode

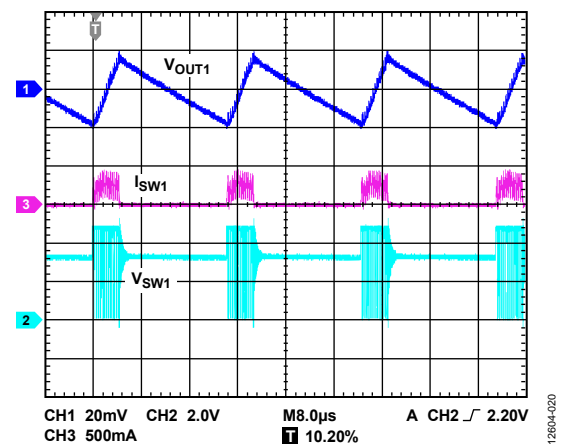

Figure 20. Typical Waveforms,  $V_{OUT1} = 3.3\text{ V}$ , Load Current = 50 mA, Auto Mode

12804-015

12804-018

12804-016

12804-019

12804-017

12804-020

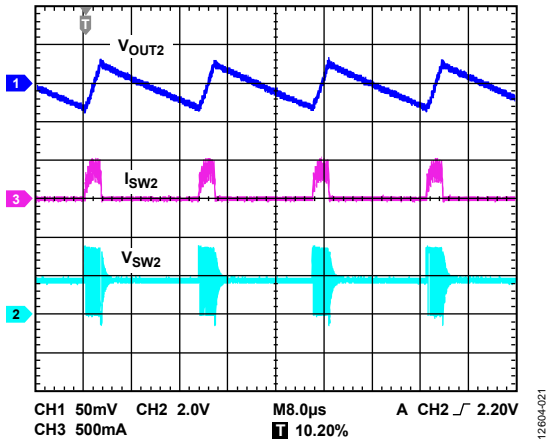

Figure 21. Typical Waveforms,  $V_{OUT2} = 1.8\text{ V}$ , Load Current = 50 mA, Auto Mode

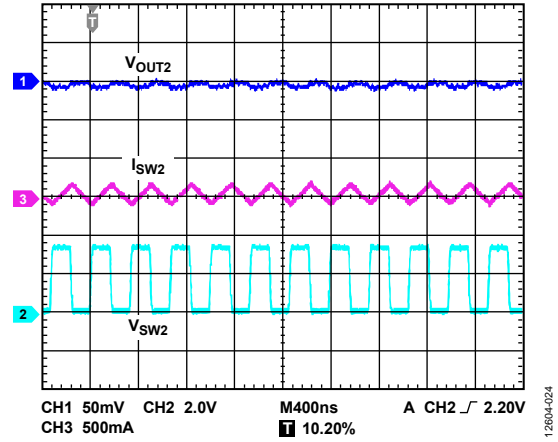

Figure 24. Typical Waveforms,  $V_{OUT2} = 1.8\text{ V}$ , Load Current = 50 mA, PWM Mode

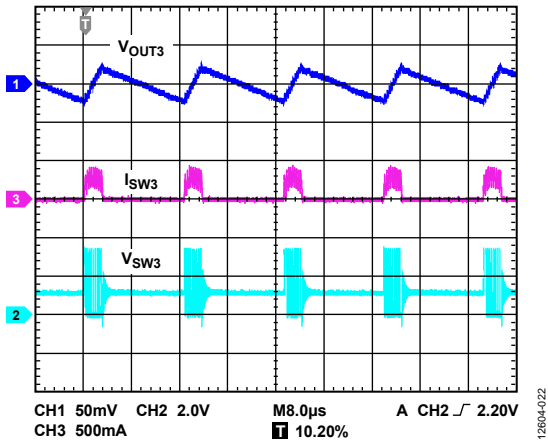

Figure 22. Typical Waveforms,  $V_{OUT3} = 1.2\text{ V}$ , Load Current = 50 mA, Auto Mode

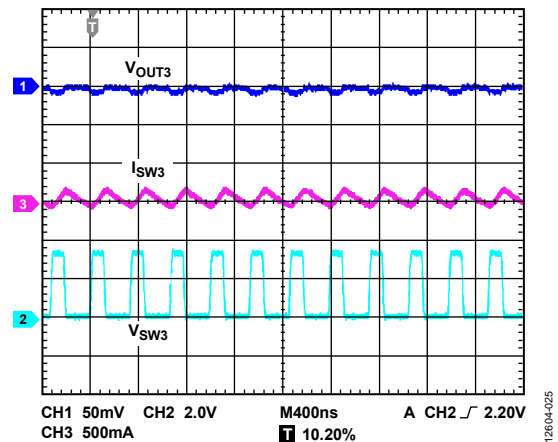

Figure 25. Typical Waveforms,  $V_{OUT3} = 1.2\text{ V}$ , Load Current = 50 mA, PWM Mode

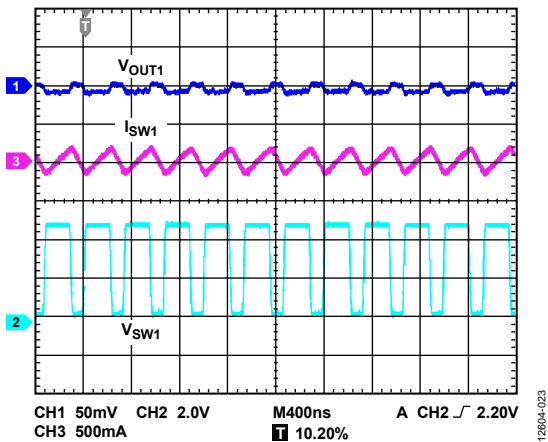

Figure 23. Typical Waveforms,  $V_{OUT1} = 3.3\text{ V}$ , Load Current = 50 mA, PWM Mode

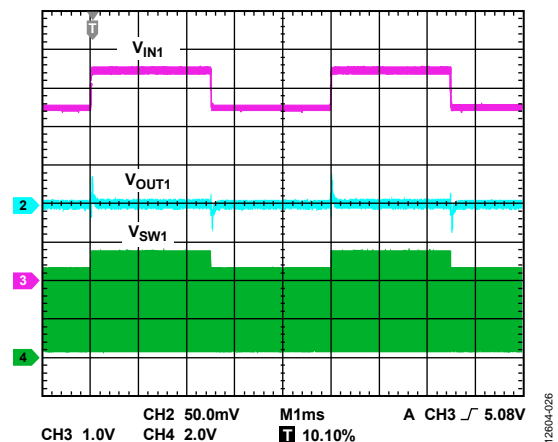

Figure 26. BUCK1 Response to Line Transient, Input Voltage from 4.5 V to 5.5 V,  $V_{OUT1} = 3.3\text{ V}$ , Load Current = 50 mA, PWM Mode

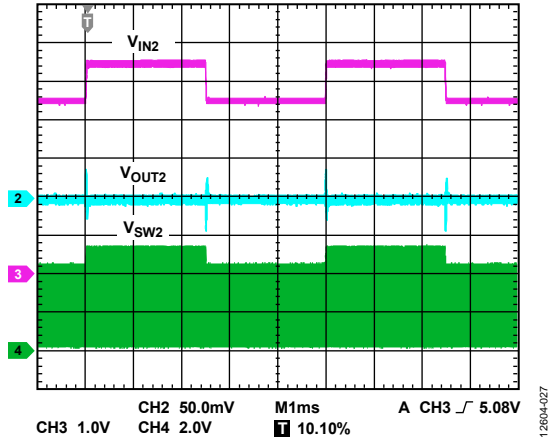

Figure 27. BUCK2 Response to Line Transient, Input Voltage from 4.5 V to 5.5 V,  $V_{OUT2} = 1.8$  V, Load Current = 50 mA, PWM Mode

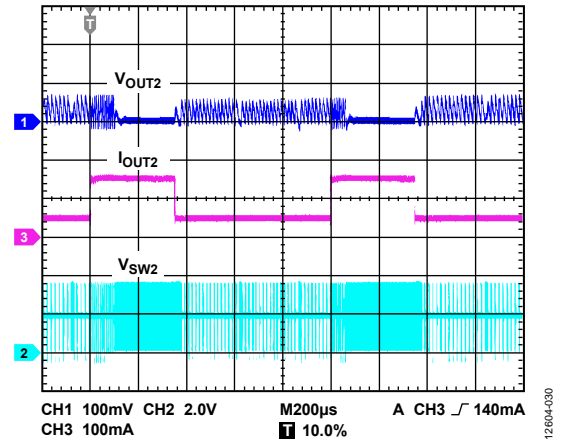

Figure 30. BUCK2 Response to Load Transient, Load Current from 50 mA to 200 mA,  $V_{OUT2} = 1.8$  V, Auto Mode

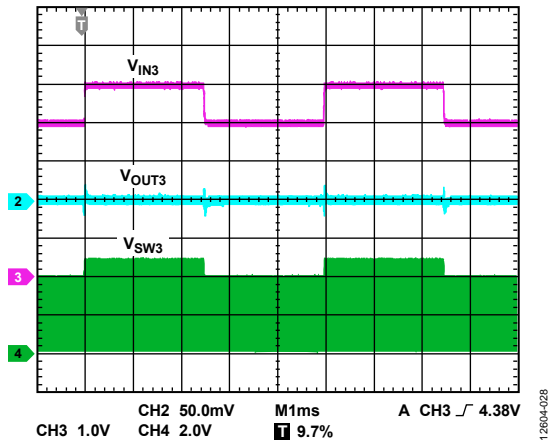

Figure 28. BUCK3 Response to Line Transient, Input Voltage from 4.0 V to 5.0 V,  $V_{OUT3} = 1.2$  V, Load Current = 50 mA, PWM Mode

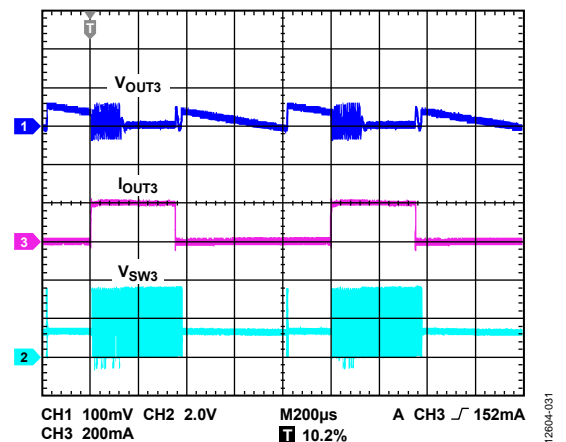

Figure 31. BUCK3 Response to Load Transient, Load Current from 1 mA to 200 mA,  $V_{OUT3} = 1.2$  V, Auto Mode

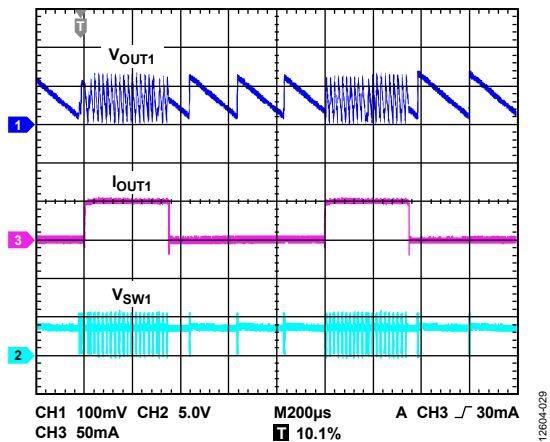

Figure 29. BUCK1 Response to Load Transient, Load Current from 1 mA to 50 mA,  $V_{OUT1} = 3.3$  V, Auto Mode

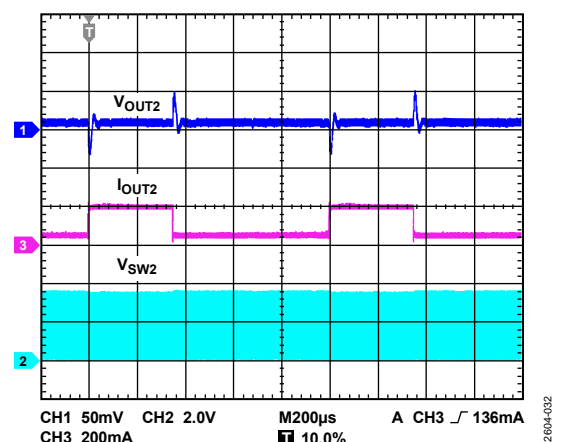

Figure 32. BUCK2 Response to Load Transient, Load Current from 1 mA to 200 mA,  $V_{OUT3} = 1.2$  V, PWM Mode

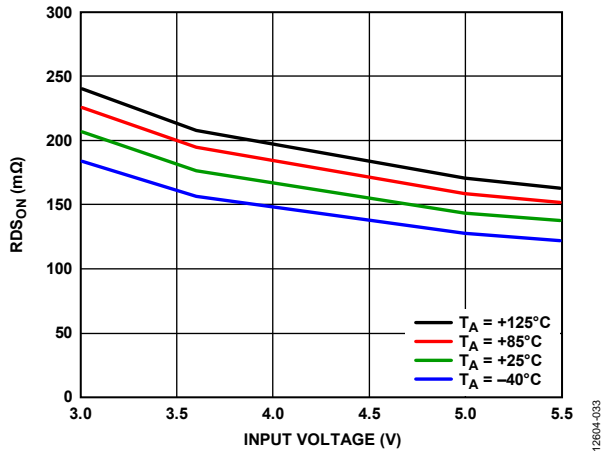

Figure 33. LFCSP PMOS RDS<sub>ON</sub> vs. Input Voltage Across Temperature

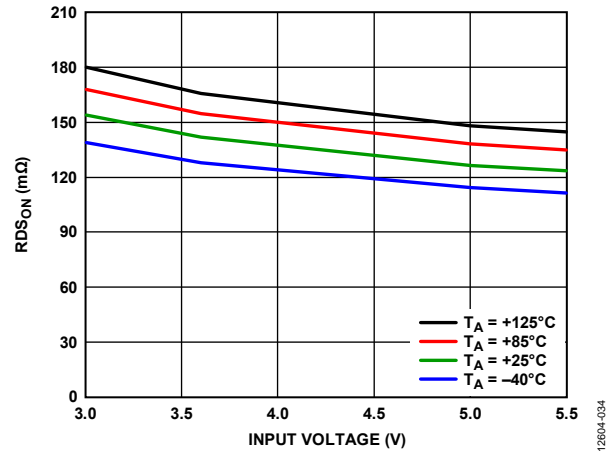

Figure 34. LFCSP NMOS RDS<sub>ON</sub> vs. Input Voltage Across Temperature

# THEORY OF OPERATION

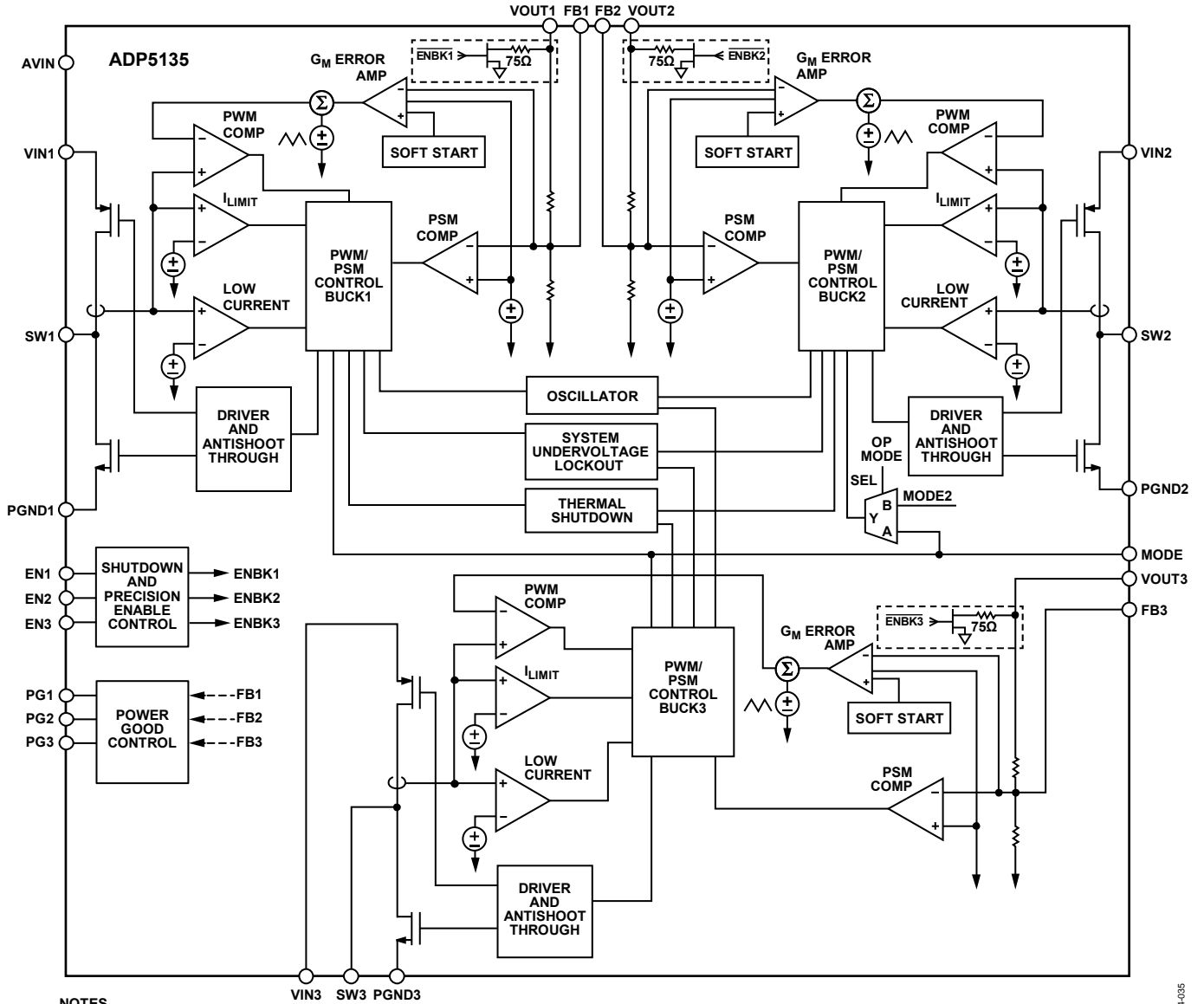

Figure 35. Detailed Functional Block Diagram

## POWER MANAGEMENT UNIT

The **ADP5135** is a micropower management unit (micro PMU) combining three step-down (buck) dc-to-dc converters. The high switching frequency and tiny 24-lead LFCSP package provide a small power management solution.

A system controller combines these high performance regulators in the micro PMU, allowing them to operate together.

The buck regulators can operate in forced PWM mode if the **MODE** pin is at a logic high level. In forced PWM mode, the buck switching frequency is always constant and does not change with the load current. If the **MODE** pin is at a logic low level, the switching regulators operate in auto PWM/PSM mode. In this mode, the regulators operate at a fixed PWM

frequency when the load current is above the PSM current threshold. When the load current falls below the PSM current threshold, the regulator enters PSM, where the switching occurs in bursts. The burst repetition rate is a function of the current load and the output capacitor value. This operating mode reduces the switching and quiescent current losses. The auto PWM/PSM mode transition is controlled independently for each buck regulator. **BUCK1** and **BUCK2** operate in phase with the internal clock, and **BUCK3** operates out of phase from it.

The **ADP5135** has individual enable pins (**EN1**, **EN2**, and **EN3**) controlling the activation of each regulator. The regulators are activated by a logic high level applied to the respective **ENx** pin. **EN1** controls **BUCK1**, **EN2** controls **BUCK2**, and **EN3** controls **BUCK3**.

Regulator output voltages are set through external resistor dividers or can be optionally factory programmed to default values (see the Ordering Guide section).

When a regulator is turned on, the output voltage ramp rate is controlled through a soft start circuit to avoid a large inrush current caused by the charging of the output capacitors.

### **Power-Good Output**

Power-good outputs are available for each buck channel to monitor their respective output voltages. The PGx pin connects to a pull-up current to drive external regulators or other circuits. In this configuration, the PGx pin goes high when the channel being monitored is in regulation and goes low when the output voltage falls below 85% of the nominal VOUTx level. The PGx pin can also drive an LED for fault monitoring. In this configuration, a red LED, for example, is biased and current sinks into the PGx pin when the output voltage falls below 85% of the nominal VOUTx level, thereby turning the LED on, and turns off when the output voltage is in regulation.

### **Thermal Protection**

In the event that the junction temperature rises above 150°C, the thermal shutdown circuit turns off all the regulators. Extreme junction temperatures can be the result of high current operation, poor circuit board design, or high ambient temperature. A 20°C hysteresis is included so that when thermal shutdown occurs, the regulators do not return to operation until the on-chip temperature drops below 130°C. When coming out of thermal shutdown, all regulators restart with soft start control.

### **Undervoltage Lockout**

To protect against battery discharge, undervoltage lockout (UVLO) circuitry is integrated into the system. If the input voltage on AVIN drops below the UVLO threshold, 2.45 V

minimum, all channels shut down. In the buck channels, both the power switch and the synchronous rectifier turn off. When the voltage on AVIN rises above the UVLO threshold, the device is enabled once more.

Alternatively, the user can request a new device model with a UVLO set at a higher level, suitable for 5 V supply applications, or to a lower level, suitable for low voltage operations. To order a device with options other than the default options listed in the Ordering Guide section, contact your local Analog Devices, Inc., sales or distribution representative.

In case of a thermal or UVLO event, the active pull-downs (if factory enabled) are enabled to quickly discharge the output capacitors. The pull-down resistors remain engaged until the thermal fault event is no longer present or when the input supply voltage falls below the power-on reset voltage level ( $V_{POR}$ ). The typical value of  $V_{POR}$  is approximately 1 V.

### **Precision Enable and Shutdown Control**

The ADP5135 has an individual enable control pin for each regulator. A voltage input to the ENx pin above the  $V_{IH\_EN}$  level puts the device out of shutdown and turns on the housekeeping block of the ADP5135. As the  $V_{ENx}$  level continues to rise above the precision enable threshold ( $V_{ENR}$ ), the regulators activate.

When  $V_{ENx}$  goes 80 mV typical below the  $V_{ENR}$  level, the regulators deactivate and, when all  $V_{ENx}$  levels continue to go down below the  $V_{IL\_EN}$  level, the device goes into shutdown mode. In this mode, the current consumption of the device drops to below 1.5  $\mu$ A.

Figure 36 shows the activation timings for the ADP5135 when the regulators are in sequence.  $V_{OUT1}$  is controlling EN2, and  $V_{OUT2}$  is controlling EN3. Also shown are the individual power-good signals (PGx) monitoring all regulators.

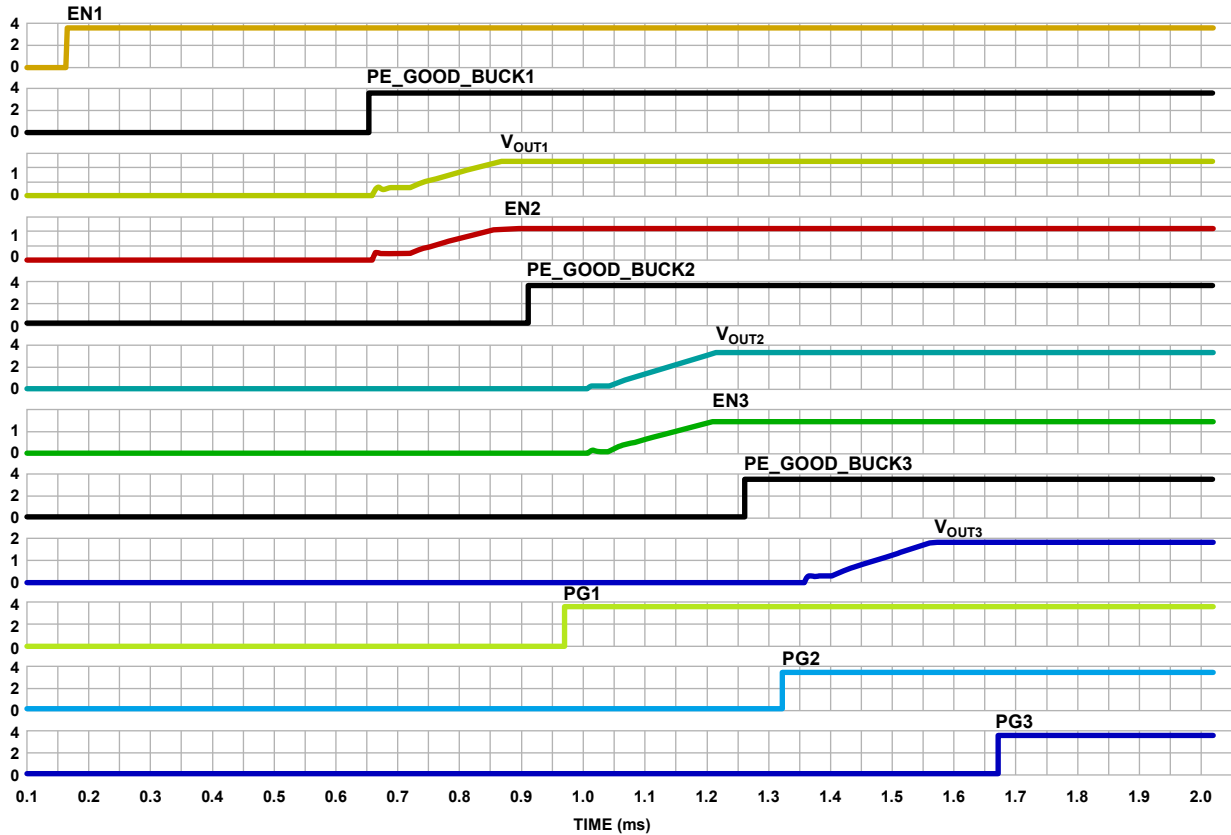

NOTES  
1. PE\_GOOD\_BUCKx ARE INTERNAL SIGNALS.

Figure 36. Regulator Sequencing on the ADP5135, Showing Precision Enable (PE) Thresholds, with Power Good

12804-036

### BUCK REGULATORS: BUCK1, BUCK2, AND BUCK3

The buck regulators use a fixed frequency and high speed current mode architecture. The buck operates with an input voltage of 3.0 V to 5.5 V.

The buck regulator output voltage is resistor programmable from 0.8 V up to 3.8 V, shown in Figure 37 for BUCK1. The ratio of R1 and R2 multiplied by the feedback voltage determines the voltage level at the output. If, for example, R1 and R2 have equal resistance values, the output voltage is set to 1.0 V. The output voltage can optionally be factory programmed to default values, as indicated in the Ordering Guide section. In this event, R1 and R2 are not needed, and FB1 can be left unconnected. In all cases, VOUT1 must be connected to the output capacitor. FB1 is 0.5 V.

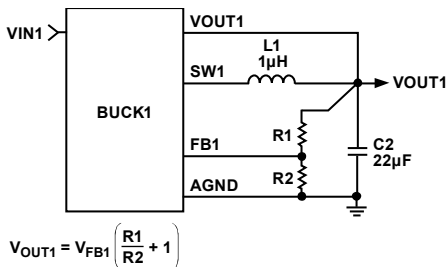

$$V_{OUT1} = V_{FB1} \left( \frac{R1}{R2} + 1 \right)$$

Figure 37. BUCK1 External Output Voltage Setting

12804-037

### Control Scheme

The buck regulators operate with a fixed frequency, current mode PWM control architecture at medium to high loads for high efficiency but shift to a power save mode (PSM) control scheme at light loads to lower the regulation power losses. When operating in fixed frequency PWM mode, the duty cycle of the integrated switches is adjusted and regulates the output voltage. When operating in PSM at light loads, the output voltage is controlled in a hysteretic manner, with higher output voltage ripple. During this time, the converter is able to stop switching and enters an idle mode, which improves conversion efficiency.

### PWM Mode

In PWM mode, the bucks operate at a fixed frequency of 3 MHz set by an internal oscillator. At the start of each oscillator cycle, the PFET switch turns on, sending a positive voltage across the inductor. Current in the inductor increases until the current sense signal crosses the peak inductor current threshold that turns off the PFET switch and turns on the NFET synchronous rectifier, sending a negative voltage across the inductor and causing the inductor current to decrease. The synchronous rectifier stays on for the rest of the cycle. The buck regulators regulate the output voltage by adjusting the peak inductor current threshold.



**Power Save Mode (PSM)**

The buck regulators smoothly transition to PSM operation when the load current decreases below the PSM current threshold. When any of the bucks enters PSM, an offset is induced in the PWM regulation level, which makes the output voltage rise. When the output voltage reaches a level that is approximately 1.5% above the PWM regulation level, PWM operation turns off. At this point, both power switches are off, and the buck regulators enter an idle mode. The output capacitor discharges until the output voltage falls to the PWM regulation voltage, at which point the device drives the inductor to make the output voltage rise again to the upper threshold. This process is repeated while the load current is below the PSM current threshold.

The ADP5135 has a dedicated MODE pin controlling the PSM and PWM operations. A logic high level applied to the MODE pin forces all bucks to operate in PWM mode. A logic low level sets the bucks to operate in auto PSM/PWM.

**PSM Current Threshold**

The PSM current threshold is set to 100 mA. The buck regulators employ a scheme that enables this current to remain accurately controlled, independent of input and output voltage levels. This scheme also ensures that there is very little hysteresis between the PSM current threshold for entry to and exit from PSM. The PSM current threshold is optimized for excellent efficiency over all load currents.

**Oscillator/Phasing of Inductor Switching**

The ADP5135 ensures that all three bucks operate at the same switching frequency when all bucks are in PWM mode.

Additionally, the ADP5135 ensures that when all bucks are in PWM mode, BUCK3 operates out of phase with BUCK1 and BUCK2, whereby the BUCK3 PFET starts conducting exactly half a clock period after the BUCK1 and BUCK2 PFETs start conducting.

**Short-Circuit Protection**

The bucks include frequency foldback to prevent output current runaway on a hard short. When the voltage at the feedback pin falls below half the target output voltage, indicating the possibility of a hard short at the output, the switching frequency is reduced to half the internal oscillator frequency. The reduction in the switching frequency allows more time for the inductor to discharge, preventing a runaway of output current.

**Buck Regulator Soft Start**

The buck regulators have an internal soft start function that ramps the output voltage in a controlled manner upon startup, thereby limiting the inrush current. This prevents possible input voltage drops when a battery or a high impedance power source is connected to the input of the converter.

**Current Limit**

Each buck regulator has protection circuitry to limit the amount of positive current flowing through the PFET switch and the amount of negative current flowing through the synchronous rectifier. The positive current limit on the power switch limits the amount of current that can flow from the input to the output. The negative current limit prevents the inductor current from reversing direction and flowing out of the load.

**100% Duty Operation**

With a drop in input voltage, or with an increase in load current, the buck regulators may reach a limit where, even with the PFET switch on 100% of the time, the output voltage drops below the desired output voltage. At this limit, the buck regulators transition to a mode where the PFET switch stays on 100% of the time. When the input conditions change again and the required duty cycle falls, the buck regulators immediately restart PWM regulation without allowing overshoot on the output voltage.

**Active Pull-Down Resistors**

All regulators have optional, factory programmable, active pull-down resistors that discharge the respective output capacitors when the regulators are disabled. The pull-down resistors are connected between VOUTx and AGND. The active pull-down resistors are disabled when the regulators are turned on. The typical value of the pull-down resistor is 75  $\Omega$ .

## APPLICATIONS INFORMATION

### BUCK EXTERNAL COMPONENT SELECTION

Trade-offs between performance parameters such as efficiency and transient response can be made by varying the choice of external components in the applications circuit, as shown in Figure 1.

#### Feedback Resistors

For the adjustable model, the total combined resistance for R1 and R2 must not to exceed 400 k $\Omega$  (see Figure 37).

#### Inductor

The high switching frequency of the ADP5135 buck regulators allows the selection of small chip inductors. For best performance, use inductor values between 0.7  $\mu$ H and 3  $\mu$ H. Suggested inductors are shown in Table 8 and Table 9.

The peak-to-peak inductor current ripple ( $I_{RIPPLE}$ ) is calculated using the following equation:

$$I_{RIPPLE} = \frac{V_{OUT} \times (V_{IN} - V_{OUT})}{V_{IN} \times f_{SW} \times L}$$

where:

$f_{SW}$  is the switching frequency.

$L$  is the inductor value.

The minimum dc current rating of the inductor must be greater than the inductor peak current. The inductor peak current ( $I_{PEAK}$ ) is calculated using the following equation:

$$I_{PEAK} = I_{LOAD(MAX)} + \frac{I_{RIPPLE}}{2}$$

Inductor conduction losses are caused by the flow of current through the inductor, which has an associated internal dc resistance (DCR). Larger sized inductors have smaller DCR, which may decrease inductor conduction losses. Inductor core losses are related to the magnetic permeability of the core material. Because the bucks are high switching frequency dc-to-dc converters, shielded ferrite core material is recommended for its low core losses and low electromagnetic interference (EMI).

#### Output Capacitor

Higher output capacitor values reduce the output voltage ripple and improve load transient response. When choosing this value, it is also important to account for the loss of capacitance due to output voltage dc bias.

Ceramic capacitors are manufactured with a variety of dielectrics, each with a different behavior over temperature and applied voltage. Capacitors must have a dielectric adequate to ensure the minimum capacitance over the necessary temperature range and dc bias conditions. X5R or X7R dielectrics with a voltage rating of 6.3 V or 10 V are recommended for best performance. Y5V and Z5U dielectrics are not recommended for use with any dc-to-dc converter because of their poor temperature and dc bias characteristics.

The worst-case capacitance accounting for capacitor variation over temperature, component tolerance, and voltage is calculated using the following equation:

$$C_{EFF} = C_{OUT} \times (1 - TEMPCO) \times (1 - TOL)$$

where:

$C_{EFF}$  is the effective capacitance at the operating voltage.

$TEMPCO$  is the worst-case capacitor temperature coefficient.

$TOL$  is the worst-case component tolerance.

In this example, the worst-case temperature coefficient ( $TEMPCO$ ) over  $-40^{\circ}\text{C}$  to  $+85^{\circ}\text{C}$  is assumed to be 15% for an X5R dielectric. The tolerance of the capacitor ( $TOL$ ) is assumed to be 10%, and  $C_{OUT}$  is 9.2  $\mu\text{F}$  at 1.8 V, as shown in Figure 38.

Substituting these values in the equation yields

$$C_{EFF} = 9.2 \mu\text{F} \times (1 - 0.15) \times (1 - 0.1) \approx 7.0 \mu\text{F}$$

To guarantee the performance of the bucks, it is imperative that the effects of dc bias, temperature, and tolerances on the behavior of the capacitors be evaluated for each application.

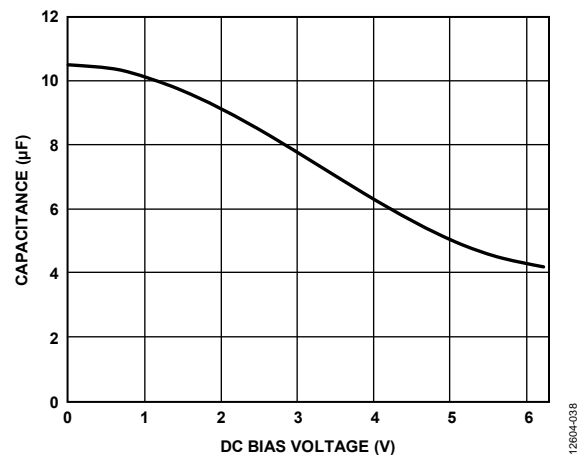

Figure 38. Capacitance vs. DC Bias Voltage

Table 8. Suggested 1.0  $\mu$ H Inductors

Vendor	Model	Dimensions (mm)	$I_{SAT}$ (mA) <sup>1</sup>	DCR (m $\Omega$ )
Murata	LQM2HPN1R0MJHL	2.5 × 2.0 × 1.2	3500	50
Würth Electronics	74438323010	2.5 × 2.0 × 1.0	4000	75
Coilcraft®	XFL4020-102ME	4.0 × 4.0 × 2.1	5100	11.9

<sup>1</sup>  $I_{SAT}$  is the saturation current.

**Table 9. Suggested 2.2 μH Inductors**

Vendor	Model	Dimensions (mm)	I <sub>SAT</sub> (mA) <sup>1</sup>	DCR (mΩ)
Würth Electronics	74438335022	3.0×3.0×1.5	3500	108
TDK	VLCF5020T-2R2N2R6-1	5.0×5.0×2.0	2620	71
Taiyo Yuden	NP04SZB2R2N	5.0×5.0×2.0	2700	42
Coilcraft	XFL4020-222ME	4.0×4.0×2.1	3500	23.5

<sup>1</sup> I<sub>SAT</sub> is the saturation current.

The peak-to-peak output voltage ripple for the selected output capacitor and inductor values is calculated using the following equation:

$$V_{RIPPLE} = \frac{I_{RIPPLE}}{8 \times f_{SW} \times C_{OUT}} \approx \frac{V_{IN}}{(2\pi \times f_{SW})^2 \times L \times C_{OUT}}$$

Capacitors with lower effective series resistance (ESR) are preferred to guarantee low output voltage ripple, as shown in the following equation:

$$ESR_{C_{OUT}} \leq \frac{V_{RIPPLE}}{I_{RIPPLE}}$$

The effective C<sub>OUT</sub> needed for stability, which includes temperature and dc bias effects, is a minimum of 7 μF and a maximum of 40 μF.

The buck regulators require 10 μF output capacitors to guarantee stability and response to rapid load variations. To transition into and out of the PWM/PSM modes, a 22 μF output capacitor can be used for applications that require larger load steps. A list of suggested capacitors is shown in Table 10. In certain applications where one or all buck regulators power a processor, the operating state is known because it is controlled by software. In this condition, the processor can drive the MODE pin according to the operating state; consequently, it is possible to reduce the output capacitor from 10 μF to 4.7 μF because the regulator does not expect a large load variation when working in PSM mode.

### Input Capacitor

Higher value input capacitors help to reduce the input voltage ripple and improve transient response. The maximum input capacitor current is calculated using the following equation:

$$I_{CIN} \geq I_{LOAD(MAX)} \sqrt{\frac{V_{OUT}(V_{IN} - V_{OUT})}{V_{IN}}}$$

To minimize supply noise, place the input capacitor as close as possible to the VINx pin of the buck regulator. As with the output capacitor, a low ESR capacitor is recommended.

The effective capacitance needed for stability, which includes temperature and dc bias effects, is a minimum of 3 μF and a maximum of 10 μF. A list of suggested capacitors is shown in Table 11 and Table 12.

**Table 10. Suggested 22 μF Capacitors**

Vendor	Type	Model	Case Size	Voltage Rating (V)
Murata	X5R	GRM188R60G226MEA0D	0603	6.3
TDK	X5R	C1608X5R0J226M080AC	0603	6.3
Taiyo Yuden	X5R	LMK212BJ226MG-T	0805	10.0

**Table 11. Suggested 10 μF Capacitors**

Vendor	Type	Model	Case Size	Voltage Rating (V)
Murata	X5R	GRM188R60J106	0603	6.3
TDK	X5R	C1608JB0J106K	0603	6.3
Taiyo Yuden	X5R	JMK107BJ106MA-T	0603	6.3
Panasonic	X5R	ECJ1VB0J106M	0603	6.3

**Table 12. Suggested 4.7 μF Capacitors**

Vendor	Type	Model	Case Size	Voltage Rating (V)
Murata	X5R	GRM188R60J475ME19D	0402	6.3
Taiyo Yuden	X5R	JMK107BJ475	0402	6.3
Panasonic	X5R	ECJ-0EB0J475M	0402	6.3

**Table 13. Suggested 1.0 μF Capacitors**

Vendor	Type	Model	Case Size	Voltage Rating (V)
Murata	X5R	GRM155B30J105K	0402	6.3
Murata	X5R	GRM155R61A105KE15D	0402	10.0
TDK	X5R	C1005JB0J105KT	0402	6.3
Panasonic	X5R	ECJ0EB0J105K	0402	6.3
Taiyo Yuden	X5R	LMK105BJ105MV-F	0402	10.0

TYPICAL APPLICATION SCHEMATICS

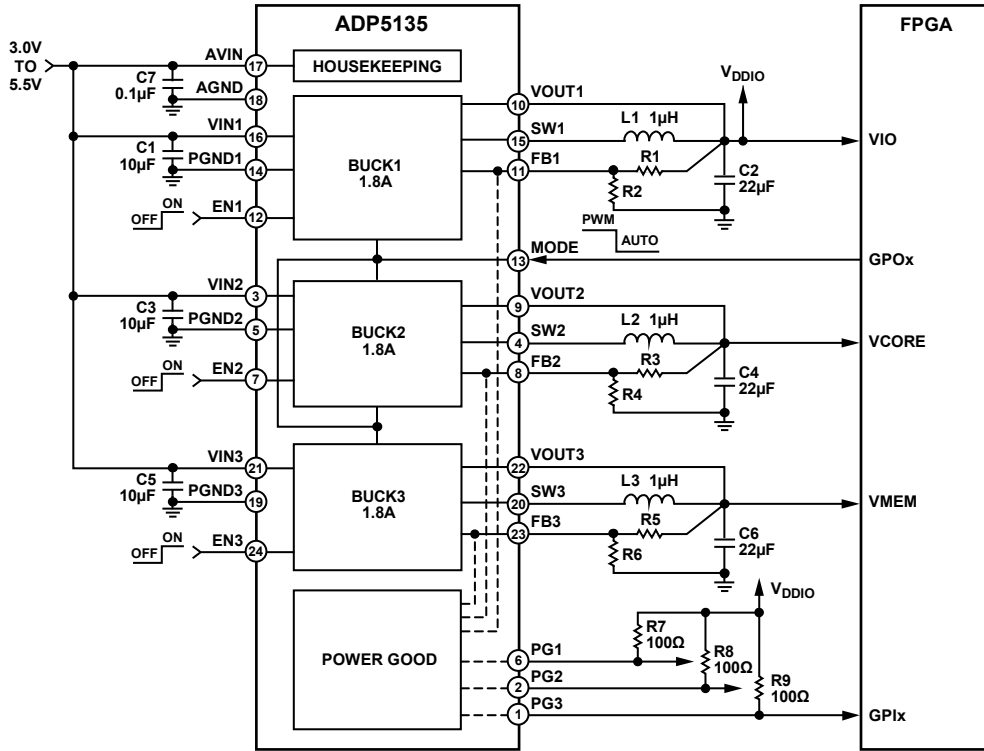

Figure 39. Processor System Power Management with PSM/PWM Control and Power Good

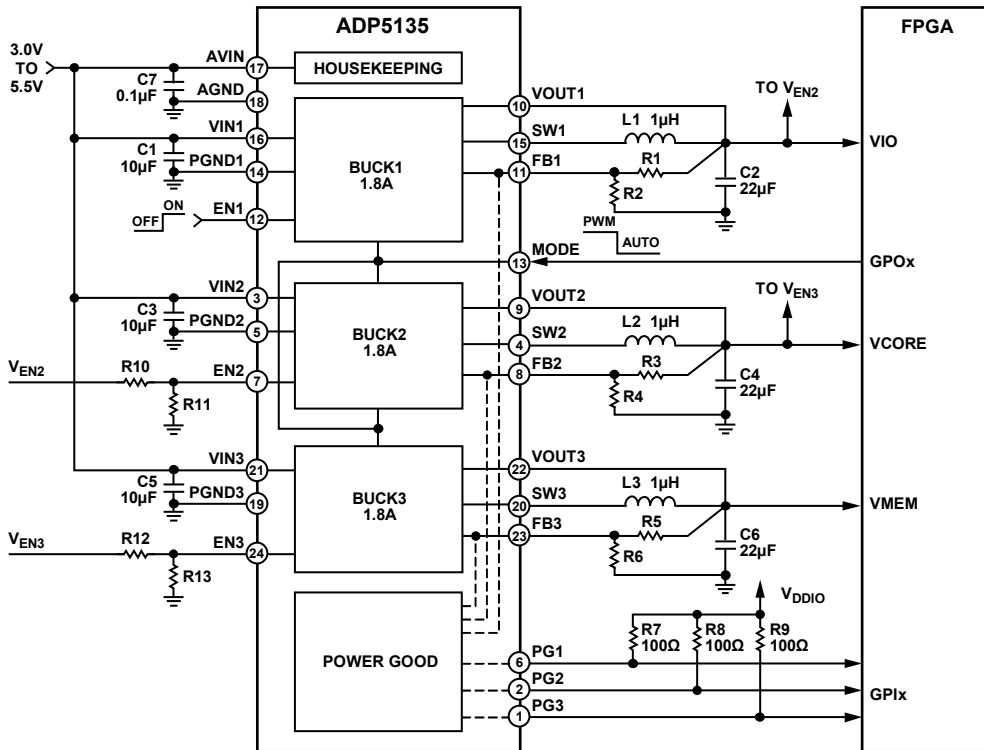

Figure 40. ADP5135 Adjustable Output Voltages with Precision Enable Pins

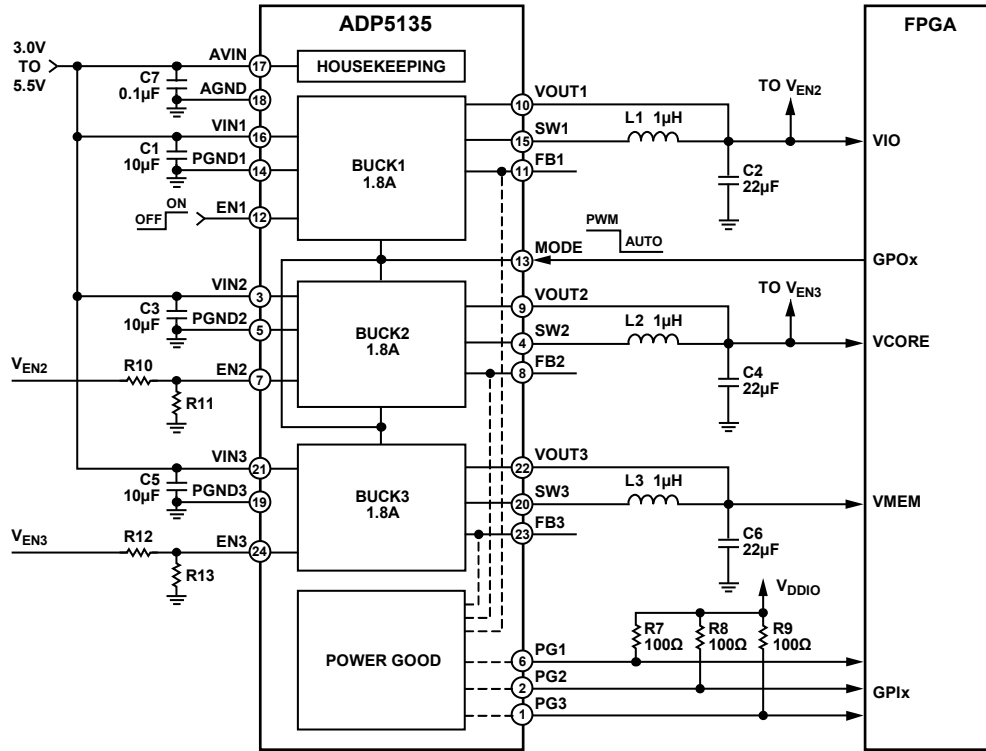

Figure 41. ADP5135 Fixed Output Voltages with Precision Enable Pins

12804-001

## POWER DISSIPATION AND THERMAL CONSIDERATIONS

The ADP5135 is a highly efficient micro PMU and, in most cases, the power dissipated in the device is not a concern. However, if the device operates at high ambient temperatures and maximum loading conditions, the junction temperature can reach the maximum allowable operating limit (125°C).

When the temperature exceeds 150°C, the ADP5135 turns off all the regulators, allowing the device to cool down. When the die temperature falls below 130°C, the ADP5135 resumes normal operation.

This section provides guidelines to calculate the power dissipated in the device and to ensure that the ADP5135 operates below the maximum allowable operating junction temperature.

The efficiency for each regulator on the ADP5135 is given by

$$\eta = \frac{P_{OUT}}{P_{IN}} \times 100\% \quad (1)$$

where:

$\eta$  is the efficiency.

$P_{OUT}$  is the output power.

$P_{IN}$  is the input power.

Power loss is given by

$$P_{LOSS} = P_{IN} - P_{OUT} \quad (2a)$$

or

$$P_{LOSS} = P_{OUT} (1 - \eta) / \eta \quad (2b)$$

Power dissipation can be calculated in several ways. The most intuitive and practical is to measure the power dissipated at the input and all the outputs. Perform the measurements at the worst-case conditions (voltages, currents, and temperature). The difference between input and output power is dissipated in the device and the inductor. Use Equation 3 to derive the power lost in the inductor and, from this, use Equation 7 to calculate the power dissipation in the ADP5135 buck converter.

A second method to estimate the power dissipation uses the efficiency curves provided for the buck regulator. When the buck efficiency is known, use Equation 2b to derive the total power lost in the buck regulator and inductor, use Equation 3 to derive the power lost in the inductor, and then calculate the power dissipation in the buck converter using Equation 7. Add the power dissipated in the three bucks to find the total dissipated power.

Note that the buck efficiency curves are typical values and may not be provided for all possible combinations of  $V_{IN}$ ,  $V_{OUT}$ , and  $I_{OUT}$ . To account for these variations, it is necessary to include a safety margin when calculating the power dissipated in the buck.

A third way to estimate the power dissipation is analytical and involves modeling the losses in the buck circuit provided by Equation 8 to Equation 11.

### BUCK REGULATOR POWER DISSIPATION

The inductor losses are external to the device, and they do not have any effect on the die temperature.

The inductor losses are estimated (without core losses) by

$$P_L \approx I_{OUT1(RMS)}^2 \times DCR_L \quad (3)$$

where:

$I_{OUT1(RMS)}$  is the rms load current of the buck regulator.

$DCR_L$  is the inductor series resistance.

$$I_{OUT1(RMS)} = I_{OUT1} \times \sqrt{1 + \frac{r}{12}} \quad (4)$$

where  $r$  is the normalized inductor ripple current.

$$r = V_{OUT1} \times (1 - D) / (I_{OUT1} \times L \times f_{SW}) \quad (5)$$

where:

$L$  is the inductance.

$f_{SW}$  is the switching frequency.

$D$  is the duty cycle.

$$D = V_{OUT1} / V_{IN1} \quad (6)$$

The power loss of the buck regulator is approximated by

$$P_{LOSS} = P_{DBUCK} + P_L \quad (7)$$

where:

$P_{DBUCK}$  is the power dissipation on one of the ADP5135 buck regulators.

$P_L$  is the inductor power losses.

The ADP5135 buck regulator power dissipation,  $P_{DBUCK}$ , includes the power switch conductive losses, the switch losses, and the transition losses of each channel. There are other sources of loss, but these are generally less significant at high output load currents, where the thermal limit of the application is. Equation 8 captures the calculation that must be made to estimate the power dissipation in the buck regulator.

$$P_{DBUCK} = P_{COND} + P_{SW} + P_{TRAN} \quad (8)$$

The power switch conductive losses are due to the output current,  $I_{OUT1}$ , flowing through the P-channel MOSFET and the N-channel MOSFET power switches that have internal resistance,  $RDS_{ON,P}$  and  $RDS_{ON,N}$ , respectively. The amount of conductive power loss is found by

$$P_{COND} = [RDS_{ON,P} \times D + RDS_{ON,N} \times (1 - D)] \times I_{OUT1(RMS)}^2 \quad (9)$$

where  $RDS_{ON,P}$  is approximately 0.19  $\Omega$ ,  $RDS_{ON,N}$  is approximately 0.14  $\Omega$  at a 25°C junction temperature, and  $V_{IN1} = V_{IN2} = 3.6$  V. At  $V_{IN1} = V_{IN2} = 5.5$  V, the values are 0.147  $\Omega$  and 0.122  $\Omega$ , respectively.

Switching losses are associated with the current drawn by the driver to turn on and turn off the power devices at the switching frequency. The amount of switching power loss is given by

$$P_{SW} = (C_{GATE\_P} + C_{GATE\_N}) \times V_{INI}^2 \times f_{SW} \quad (10)$$

where:

$C_{GATE\_P}$  is the P-channel MOSFET gate capacitance.

$C_{GATE\_N}$  is the N-channel MOSFET gate capacitance.

For the [ADP5135](#), the total of ( $C_{GATE\_P} + C_{GATE\_N}$ ) is approximately 150 pF.

The transition losses occur because the P-channel power MOSFET cannot be turned on or off instantaneously, and the SWx node takes some time to slew from near ground to near  $V_{OUT1}$  (and from  $V_{OUT1}$  to ground). The amount of transition loss ( $P_{TRAN}$ ) is calculated by

$$P_{TRAN} = V_{INI} \times I_{OUT1} \times (t_{RISE} + t_{FALL}) \times f_{SW} \quad (11)$$

where  $t_{RISE}$  and  $t_{FALL}$  are the rise time and the fall time, respectively, of the switching node, SWx. For the [ADP5135](#), the rise and fall times of SWx are in the order of 5 ns.

If Equation 1 to Equation 11 and their associated parameters are used for estimating the converter efficiency, note that the equations do not describe all of the converter losses, and the parameter values given are typical numbers. The converter performance also depends on the choice of passive components and board layout; therefore, include a sufficient safety margin in the estimate.

The total power dissipation in the [ADP5135](#) simplifies to

$$P_D = P_{D\_BUCK1} + P_{D\_BUCK2} + P_{D\_BUCK3} \quad (12)$$

## JUNCTION TEMPERATURE

In cases where the board temperature,  $T_A$ , is known, the thermal resistance parameter,  $\theta_{JA}$ , can be used to estimate the junction temperature rise.  $T_J$  is calculated from  $T_A$  and  $P_D$  using the formula

$$T_J = T_A + (P_D \times \theta_{JA}) \quad (13)$$

Refer to Table 6 for the thermal resistance values of the LFCSP package. A very important factor to consider is that  $\theta_{JA}$  is based on a 4-layer, 4 in × 3 in, 2.5 oz copper printed circuit board (PCB), as per JEDEC standard, and real applications may use different sizes and layers. It is important to maximize the copper used to remove the heat from the device. Copper exposed to air dissipates heat better than copper used in the inner layers. Solder the exposed pad to the ground plane with several vias.

If the case temperature can be measured, the junction temperature is calculated by

$$T_J = T_C + (P_D \times \theta_{JC}) \quad (14)$$

where  $T_C$  is the case temperature and  $\theta_{JC}$  is the junction to case thermal resistance provided in Table 6.

When designing an application for a particular ambient temperature range, calculate the expected [ADP5135](#) power dissipation ( $P_D$ ) due to the losses of all channels by using Equation 8 to Equation 12. From this power calculation, the junction temperature,  $T_J$ , can be estimated using Equation 13.

The reliable operation of the converter can be achieved only if the estimated die junction temperature of the [ADP5135](#) (Equation 14) is less than 125°C. Reliability and mean time between failures (MTBF) are highly affected by increasing the junction temperature. Additional information about product reliability can be found in the [ADI Reliability Handbook](#) at [www.analog.com/UG-311](http://www.analog.com/UG-311).

## PCB LAYOUT GUIDELINES

Poor layout can affect [ADP5135](#) performance, causing EMI and electromagnetic compatibility (EMC) problems, ground bounce, and voltage losses. Poor layout can also affect regulation and stability. A good layout is implemented using the following guidelines. Also, refer to the [ADP5135CP-EVALZ](#) user guide.

- Place the inductor, input capacitor, and output capacitor close to the IC using short tracks. These components carry high switching frequencies, and large tracks act as antennas.
- Route the output voltage path away from the inductor and SWx node to minimize noise and magnetic interference.
- Maximize the size of ground metal on the component side to help with thermal dissipation.
- Connect VIN1, VIN2, VIN3, and AVIN together close to the IC using short tracks.
- Use a ground plane with several vias connecting to the component side ground to further reduce noise interference on sensitive circuit nodes.
- For best performance, connect the input capacitors very close to the pins as follows: place the AVIN capacitor between the AVIN and AGND pins, place the VIN1 capacitor between the VIN1 and PGND1 pins, place the VIN2 capacitor between the VIN2 and PGND2 pins, and place the VIN3 capacitor between VIN3 and PGND3.



OUTLINE DIMENSIONS

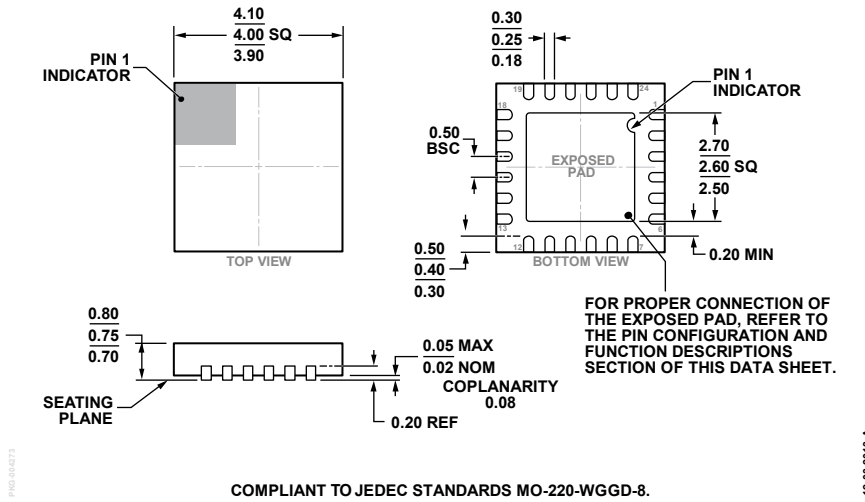

Figure 42. 24-Lead Lead Frame Chip Scale Package [LFCSP\_WQ]  
 4 mm × 4 mm Body, Very Very Thin Quad  
 (CP-24-15)  
 Dimensions shown in millimeters

ORDERING GUIDE

Model <sup>1</sup>	Temperature Range	Output Voltage <sup>2</sup>	UVLO <sup>3</sup>	Active Pull-Down <sup>4</sup>	Package Description	Package Option
ADP5135ACPZ-R7	-40°C to +125°C	Adjustable	Mid	Enabled on all channels	24-Lead LFCSP_WQ	CP-24-15
ADP5135CP-EVALZ					Evaluation Board	

<sup>1</sup> Z = RoHS Compliant Part.  
<sup>2</sup> For additional options, contact a local sales or distribution representative. Additional options available are:  
 BUCK1, BUCK2, BUCK3: 3.3 V, 3.0 V, 2.8 V, 2.5 V, 2.3 V, 2.0 V, 1.8 V, 1.6 V, 1.5 V, 1.4 V, 1.3 V, 1.2 V, 1.1 V, 1.0 V, 0.9 V, or adjustable.  
<sup>3</sup> UVLO: low, mid, or high. To order a device with other than the default options listed, contact your local Analog Devices sales or distribution representative.  
<sup>4</sup> BUCK1, BUCK2, BUCK3: active pull-down resistor is programmable to be either enabled or disabled.