

IB IL EX-IS TEMP 4 RTD/TC-PAC

Intrinsically safe inline temperature input terminal
for hazardous locations



Data sheet
2968_en_A

© PHOENIX CONTACT 2012-02-27

1 Description

The IB IL EX-IS TEMP 4 RTD/TC-PAC terminal is an intrinsically safe temperature input module for RTD and thermocouple temperature sensors right into Zone 1 or 0. The terminal, and accompanying intrinsically safe power supply (IB IL EX-IS PWR IN-PAC), is installed in Zone 2 or safe area.

The terminal provides four independently configurable input channels for either resistance or thermocouple sensors.

2 Features

- Four single-ended temperature inputs for the connection of RTD, thermocouple, mV or resistance signals
- Internal cold-junction compensation
- Measured values can be represented in three different formats
- Mean-value generation of measured values
- Diagnostic indicators
- Communication via either process data or parameter channel (PCP)
- Channels are independently configurable
- Resolution up to 16-bits (depends on the representation format and the measuring range)
- -25... +60°C operating range
- Shield termination



This data sheet is only valid in association with the IB IL SYS PRO UM E user manual or the Inline system manual for your bus system.



Make sure you always use the latest documentation.
It can be downloaded at www.phoenixcontact.net/catalog.



This data sheet is valid for all products listed on page 3:

3 Table of contents

1 Description..... 1

2 Features 1

3 Table of contents 2

4 Ordering data..... 3

5 Technical data 3

6 Internal circuit diagram 7

7 Electrical isolation 8

8 Local diagnostic and status indicators and terminal point assignment..... 8

 8.1 Local diagnostic and status indicators..... 8

 8.2 Terminal point assignment for each connector 8

9 Safety regulations installation notes 8

 9.1 Special conditions for safe use..... 8

 9.2 Safety instructions:..... 9

10 Connection notes10

 10.1 Power budget..... 10

11 Connection examples 11

12 Configuration and analog values..... 11

13 Programming data/configuration data..... 12

 13.1 INTERBUS 12

 13.2 Other bus systems 12

14 Process data..... 12

15 OUT process data words 12

 15.1 Output word OUT1 (control word) 12

 15.2 Configuration via process data 13

 15.3 Read configuration via process data 13

 15.4 Read temperature values via process data 15

 15.5 Read device information via process data 15

16 Formats for the representation of measured values (IN2 to IN5)..... 16

 16.1 Format: "IB IL" (default setting) 16

 16.2 Format: "S7-Compatible" 17

17 PCP communication 17

 17.1 Object dictionary 18

 17.2 Configuration via PCP 19

 17.3 Temperature values object..... 19

 17.4 DiagState object..... 20

4 Ordering data

Products

Description	Type	Order No.	Pcs./Pkt.
Terminal with four temperature input channels; 500 kbps transmission speed; includes accessories (connectors and labeling fields)	IB IL EX-IS TEMP 4 RTD/TC-PAC	2869913	1

Documentation

Description	Type	Order No.	Pcs./Pkt.
User manual: "Configuring and Installing the INTERBUS Inline Product Range"	IB IL SYS PRO UM E	2743048	1
User manual: "Automation Terminals of the Inline Product Range"	IL SYS INST UM E	2698737	1

5 Technical data

General data

Housing dimensions (width x height x depth)	48.8 mm x 136.8 mm x 71.5 mm
Weight	222 g (without connectors)
Operating mode	Process data mode with 5 words/1 word PCP
Transmission speed	500 kbps
Connection method for sensors	2- and 3-wire technology (shielded)
Permissible temperature (operation)	-25°C to +60°C
Permissible temperature (storage/transport)	-25°C to +85°C
Permissible humidity (operation/storage/transport)	10% to 95%, according to DIN EN 61131-2
Permissible air pressure (operation/storage/transport)	70 kPa to 106 kPa (up to 3000 m above sea level)
Degree of protection	IP20 according to IEC 60529
Protection class	Class 3 according to VDE 0106, IEC 60536
Connection data for connector	
Connection method	Spring-cage terminals
Conductor cross section	0.2 mm ² - 1.5 mm ² (solid or stranded), 24 - 16 AWG

Interface

Local bus	Data routing
-----------	--------------

Power consumption

Communications power U_L	5 V
Current consumption from U_L	100 mA (typical)/120 mA (maximum)
I/O supply voltage U_{EX}	28 V DC
Current consumption at U_{EX}	90 mA (typical)
Total power consumption	500 mW (typical)/650 mW (maximum)

Hazardous location ratings

Module supply Voltage U_{EX}^1	28 V DC		
Voltage output U_o	5.88 V DC		
Current output I_o	95 mA		
Power output P_o	139 mW		
	IIC	IIB	IIA
Capacitance C_o^2	42 μ F	999 μ F	999 μ F
Inductance L_o^2	0.984 mH	2.9 mH	7.8 mH

¹ $U_{EX} = U_m$ as listed in the SIRA Certification

² The quoted entity parameters of C_o and L_o are applicable for the distributed capacitance and inductance in cable. Where there is circuit capacitance or inductance in the connected equipment (represented by C_i and L_i respectively), then these values shall not exceed 50% of the quoted C_o and L_o .

Supply of the module electronics and I/O through the bus coupler/power terminal

Connection method	Potential routing
-------------------	-------------------

Analog inputs

Number	4 (configurable as RTD, thermocouple, mV or resistance)
Signals/resolution in the process data word (quantization)	See tables on page 16 and onwards
Measured value representation	In the following formats: IB IL (15 bits with sign bit) S7-compatible (15 bits with sign bit)



Please read the notes on page 16 on measured value representation in "IB IL" format.

Digital filtering (mean-value generation)	First order lag filter (tau) selectable as 100 or 1000 ms None or over 4, 16 or 32 measured values Default setting: 16 measured values
Conversion time of the A/D converter	10 μ s, maximum
Limit frequency (-3 dB) of the input filters	< 30 Hz
Bus synchronism	Yes
Transient protection	Yes

RTD input characteristics

Design	Ni DIN 100, 120, 500, 1000 Pt DIN 100, 200, 1000, 5000
Connection	2- or 3-wire
Input resistance	0-800 Ω 0-5000 Ω
Accuracy @ 25°C (3-wire)	0.2% \pm 0.5°C
Maximum drift	
-25°C...+25°C	\pm 1.5°C
+25°C...+60°C	\pm 1.05°C
Linearity error	\pm 1 LSB

Thermocouple and mV input characteristics

Sensor type	J, K, E, R, S, T On-board CJC ±100 mV
Connection	2-wire, shield
Accuracy @ 25°C	
Resistance input	0.5% ±0.1 Ω
mV input	0.1% ±50 μV
Thermocouple (J, K, E, T type)	0.1% ±2.5°C
Thermocouple (R, S type)	0.1% ±5°C
Maximum drift	
Resistance input	
-25°C...+25°C	±1.2 Ω
+25°C...+60°C	±0.85 Ω
Thermocouple input	±0.30 μV/°C
mV input	0.30 μV/°C
Linearity error	±1 LSB

Input measuring range (Thermocouple and mV)

	Low limit	High limit
K	-270°C	+1372°C
J	-210°C	+1200°C
E	-270°C	+1000°C
R	-50°C	+1768°C
S	-50°C	+1768°C
T	-270°C	+400°C
CJC	-40°C	+80°C
mV	-100 mV	+100 mV

Input measuring range (RTD)

	Low limit	High limit
Pt	-200°C	+850°C
Ni	-60°C	+250°C
Resistance 1	0 Ω	800 Ω
Resistance 2	0 Ω	5000 Ω



All percentage values refer to the relevant measuring range final value.
The values refer to nominal operation in the recommended mounting position (horizontal wall mounting).

Additional tolerances influenced by electromagnetic fields

Type of Electromagnetic Interference	Typical deviation from the measuring range final value (voltage input)	Typical deviation of the measuring range final value (current input)
	Relative	Relative
Electromagnetic fields; field strength 10 V/m according to EN 61000-4-3/IEC 61000-4-3	< ±1%	< ±1%
Conducted interference Class 3 (test voltage 10 V) according to EN 61000-4-6/IEC 61000-4-6	< ±1%	< ±1%
Fast transients (burst) 4 kV supply, 2 kV input according to EN 61000-4-4/IEC 61000-4-4	< ±1%	< ±1%

Safety equipment

Inputs Transient surge protection via arresters

Electrical isolation/isolation of the voltage areas



NOTE:

To provide electrical isolation between the logic level and the I/O area, it is necessary to supply the station bus coupler and the sensors connected to the analog input terminal described here from separate power supply units. Interconnection of the power supply units in the 24 V area is not permitted. (See also user manual.)

Common potentials

The 4 analog channels have the same potential. The 28 V U_{EX} and 5 V U_L are separate potential areas. The FE and shield have the same potential.

Separate potentials in the system consisting of bus coupler/power terminal and I/O terminal

- Test distance

5 V supply (local bus), 28 V supply U_{EX} /analog I/O

5 V supply (local bus), 28 V supply U_{EX} /functional earth ground

Analog I/O/functional earth ground

- Test voltage

500 V AC, 50 Hz, 1 min.

500 V AC, 50 Hz, 1 min.

500 V AC, 50 Hz, 1 min.

Error messages to the higher-level control or computer system

Failure of the internal U_{EX} voltage supply	Yes, I/O error message sent to the bus coupler
Failure of or insufficient communications power U_L	Yes, I/O error message sent to the bus coupler
Peripheral fault/user error	Yes, error message via the IN process data (see page 16)

Conformance/approvals

CE	94/9/EC EN 60079-0:2009 EN 60079-11:2007 EN 60079-15:2010
ATEX	Sira 09ATEX2339X; Ex nA [ia Ga Da] IIC T4 Gc
IECEX	IECEX SIR 10.0033X; Ex nA [ia Ga Da] IIC T4 Gc
	Ex II 3(1)GD

For the latest approvals, please visit www.phoenixcontact.com.

6 Internal circuit diagram

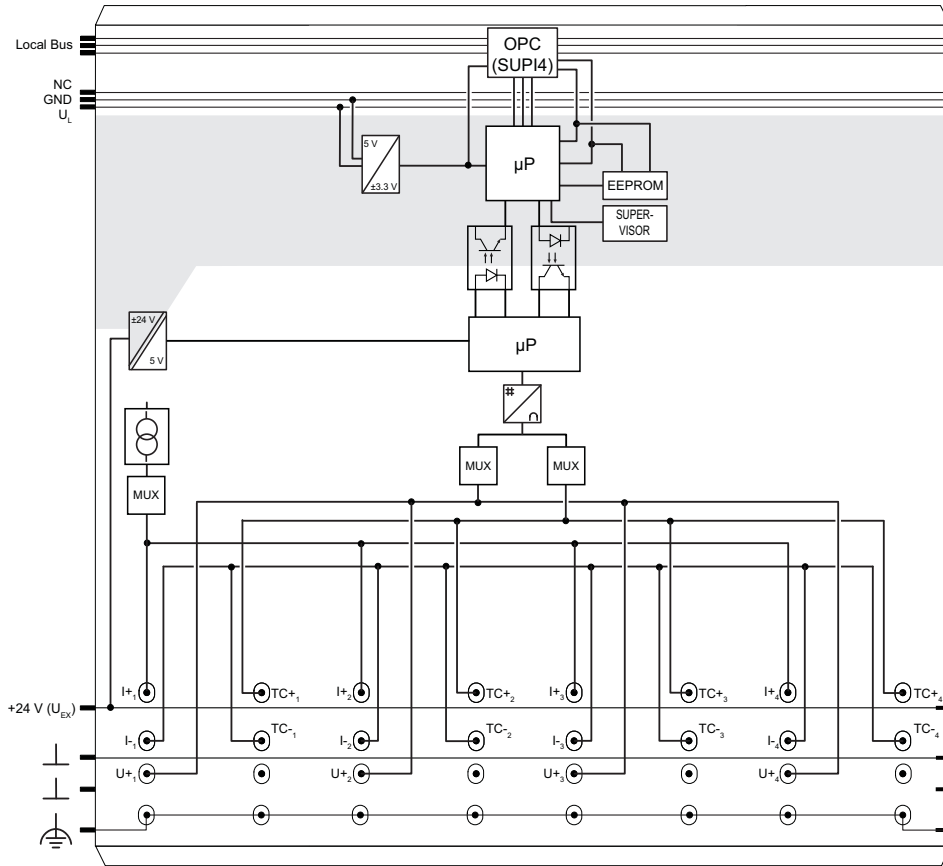









Figure 1 Internal wiring of the terminal points

Key:

	Protocol chip		Electrically erasable programmable read-only memory
	Power supply unit with electrical isolation		Digital/analog converter
	Optocoupler		Multiplexer
	Microprocessor		Microprocessor monitoring



Other symbols used are explained in the IB IL SYS PRO UM E user manual or in the Inline system manual for your bus system.

7 Electrical isolation

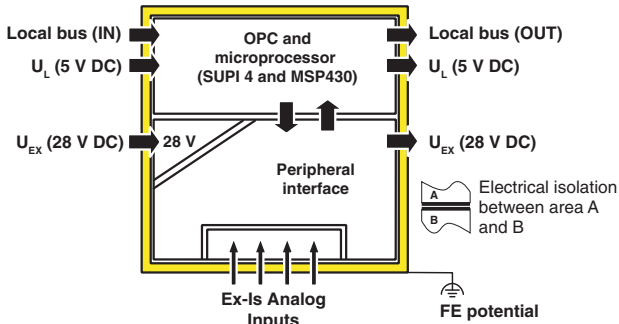

Figure 2 Electrical isolation of the individual function areas

8 Local diagnostic and status indicators and terminal point assignment

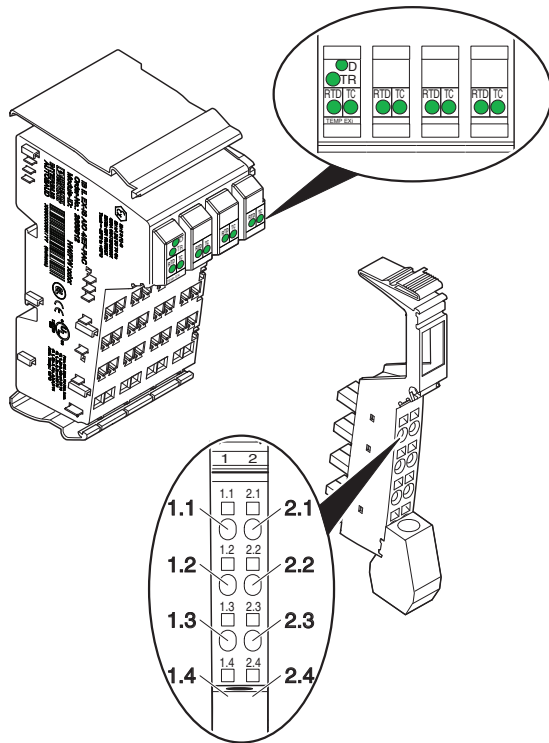

Figure 3 IB IL EX-IS TEMP 4 RTD/TC-PAC terminal with an appropriate connector

8.1 Local diagnostic and status indicators

Des.	Color	Meaning
D	Green	Diagnostics
	0.5 Hz	Local bus stop
	2 Hz	Peripheral fault or U _{EX} low or off
	4 Hz	Local bus failure
TR	Green	PCP communication active
RTD	Green (on)	Channel on and OK
	Red (on)	Broken wire or under/over range
TC	Green (on)	Channel on and OK
	Red (on)	Broken wire or under/over range

8.2 Terminal point assignment for each connector

Terminal Points	Signal	Assignment
1.1	RTD I ₊	Excitation for RTD on channel x
1.2	RTD I ₋	Return for RTD on channel x
1.3	RTD U ₊	Sense for RTD on channel x (3-wire only)
1.4	Shield	Shield connection
2.1	TC +	Thermocouple channel x
2.2	TC -	Thermocouple return for channel x
2.3	-	Not used
2.4	Shield	Shield connection

x = 1 to 4

9 Safety regulations installation notes



For a list of terminals that are approved for the potentially explosive areas of Zone 2, please refer to the AH EN IL EX ZONE 2 application note. Verify use by checking the label on the Inline terminal and the packaging.



WARNING: Explosion hazard
The following conditions must be observed to adhere to the ATEX 94/9/EC directive.

9.1 Special conditions for safe use

The module shall only be supplied from the IB IL EX-IS PWR IN-PAC module.

If the module is installed in a zone 2 hazardous area, it shall be housed in an enclosure that is coded Ex nA, Ex e, Ex d or Ex p. If the module is installed in a zone 22 or 21 hazardous area, it shall be housed in an enclosure that is coded Ex tD

or Ex t. For some types of enclosure, additional certification is required to permit the installation of the module within the enclosure. Reference should be made to the enclosure certificate. The installer shall ensure that the maximum ambient temperature of the module, when installed, is not exceeded.

If the module is installed in a non-hazardous area, the enclosure or location shall provide suitable protection. This may be either by the use of an enclosure approved for use in zones 1, 2, 21, or 22 or otherwise meet the following requirements:

- Non-metallic enclosures must be capable of withstanding the thermal endurance requirements of IEC 60079-0 prior to impact and IP54 testing.
- Any enclosure must be capable of withstanding an impact of 7J or the module is otherwise protected from impact.
- The enclosure or location must provide an ingress protection of at least IP54.
- If exposed to sunlight, non-metallic enclosures must be capable of meeting the requirements of IEC 60079-0 clause 26.10 regarding resistance to light.

The installer is responsible for ensuring that the mounting of the module does not reduce the segregation distances between different modules. There shall be a minimum of 6 mm between any intrinsically safe terminals and other conductors or earthed metal, in accordance with IEC 60079-14:2007 clause 12.2.3. In addition, there shall be a minimum of 50 mm between the intrinsically safe terminals of the module and any non-intrinsically safe terminals.

When the module is mounted in a zoned area, live connection and disconnection of the module from the rail is only permitted if the potentially explosive atmosphere is shown to be absent.

The four channels of the IB IL EX-IS TEMP 4 RTD/TC-PAC shall be treated as separate, intrinsically safe circuits.

Each channel shares a common zero volts with the other channels in the IB IL EX-IS TEMP 4 RTD/TC-PAC module as well as other IB IL EX-IS TEMP 4 RTD/TC-PAC modules and non-isolated IB IL EX-IS...IO... modules connected to the same IB IL EX-IS PWR IN-PAC (power supply) module. If the field devices do not maintain 500 V AC isolation from earth/ground, then all the non-isolated devices from the same IB IL EX-IS PWR IN-PAC module shall be installed in a location (such as the same vessel) where a difference in earth/ground potential is unlikely to occur. If the field devices maintain 500 V AC isolation from earth/ground, there is no such limitation.

The quoted entity parameters of C_o and L_o are applicable for the distributed capacitance and inductance in cable. Where there is circuit capacitance or inductance in the connected

equipment (represented by C_i and L_c respectively), these values shall not exceed 50% of the quoted C_o and L_o .

9.2 Safety instructions:

Installation instructions

The device is an associated equipment of the “intrinsically safe” protection type and suitable for installation in zone 2. Follow the installation instructions.

Installation, operation and maintenance may only be carried out by qualified personnel.

Always remove power from Inline station before installing or removing any Inline terminal.

Comply with the valid safety regulations (including national safety regulations) for the installation and operation, accident prevention regulations, and the general rules and regulations pertaining to technology. The safety relevant data may be derived from the operating instructions and the certificates (EC type examination certificate, possibly additional ratings).

Access to the circuits within the device is prohibited. Do not repair the device yourself, but replace it with an equivalent device. Repairs may only be carried out by the manufacturer.

The IP20 degree of protection (IEC 60529/EN 60529) is intended for a clean and dry environment. Do not expose the device to any mechanical or thermal influences which exceed the limits described.

Intrinsic safety

When carrying out measurements on the intrinsically safe side, it is imperative that you observe the relevant regulations regarding connecting intrinsically safe electrical equipment. Only use equipment approved for intrinsically safe circuits.

If the device was used in circuits which are not intrinsically safe, it is forbidden to use it again in intrinsically safe circuits. Label the device clearly as being not intrinsically safe.

Installation in Zone 2

Observe the specified conditions for use in potentially explosive areas! Use a suitable housing of the minimum protection IP54 for the installation. Within this context observe the requirements of IEC 60079-14/EN 60079-14, i.e., steel housing with a wall thickness of 3 mm.

Do not connect any live cables/lines within the potentially explosive area.

Only use IB IL EX-IS...IO... modules of category 3G (ATEX 94/9EG).

Potentially dust-explosive areas

The device is not designed for use in environments capable of dust explosions.

Only make the connection to the intrinsically safe circuit in potentially dust-explosive areas of zones 20, 21 and 22 if the equipment connected to this circuit is certified for this zone (e.g., category 1D, 2D or 3D).

from the IB IL EX-IS PWR IN-PAC. The maximum current draw is 1000 mA.



Additional information and examples about power budget calculation can be found on the Power Supply data sheet.

10 Connection notes



NOTE:

Always connect the analog sensors using shielded, twisted-pair cables.

Connect the shielding to the terminal using the shield connection clamp. The clamp connects the shield to FE on the module side. Avoid connection to FE from both sides.

10.1 Power budget

The IB IL EX-IS PWR IN-PAC provides power to the IB IL EX-IS TEMP 4 RTD/TC-PAC terminal in two ways:

- 1000 mA is available for the logic functions (U_L).
- 1000 mA is available for the I/O functions (U_{EX}).

The number of terminals that can be powered by the IB IL EX-IS PWR IN-PAC varies according to the type of terminal and the number and type of I/O connections.

Based on the logic functions, the maximum number of terminals that can be connected is 10.

The IB IL EX-IS TEMP 4 RTD/TC-PAC terminal draws different power depending on the type of connection. To determine the number of I/O points that can be connected, refer to Table 1.

Table 1 U_{EX} current draw

	IB IL EX-IS TEMP 4 RTD/TC-PAC
Terminal overhead	45 mA
Input	25 mA

To calculate the power requirements of a system, list the number and type of each connected point. From this list, determine the number and type of terminals required.

Multiply the number of each I/O point by the appropriate current draw listed in Table 1.

Add the terminal overhead current for each terminal used.

The sum of the I/O point current draw and the terminal overhead current draw determines the total current draw

11 Connection examples



Use a connector with shield connection when installing the sensors. Figure 4 shows the connection schematically.

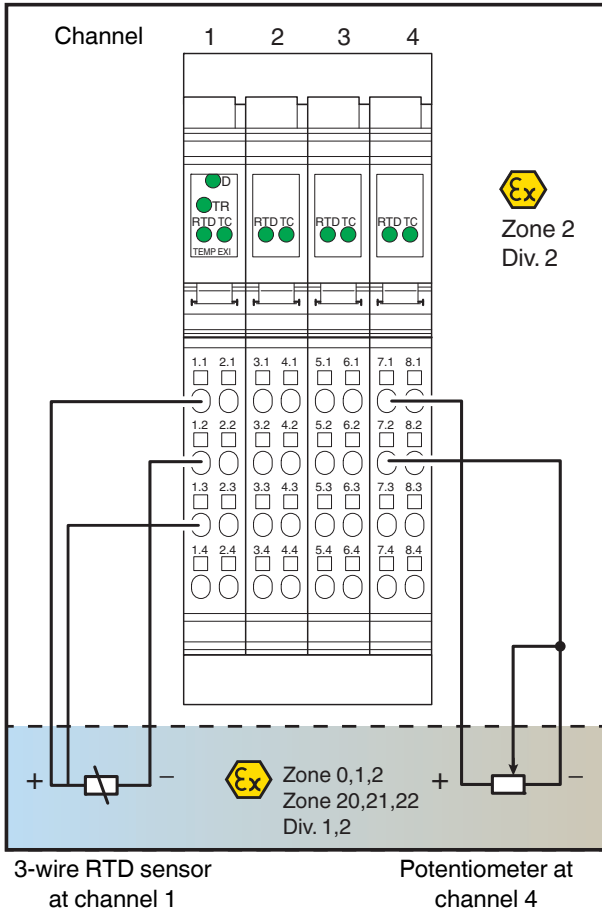

Figure 4 Connection of 3-wire RTD and potentiometers sensors

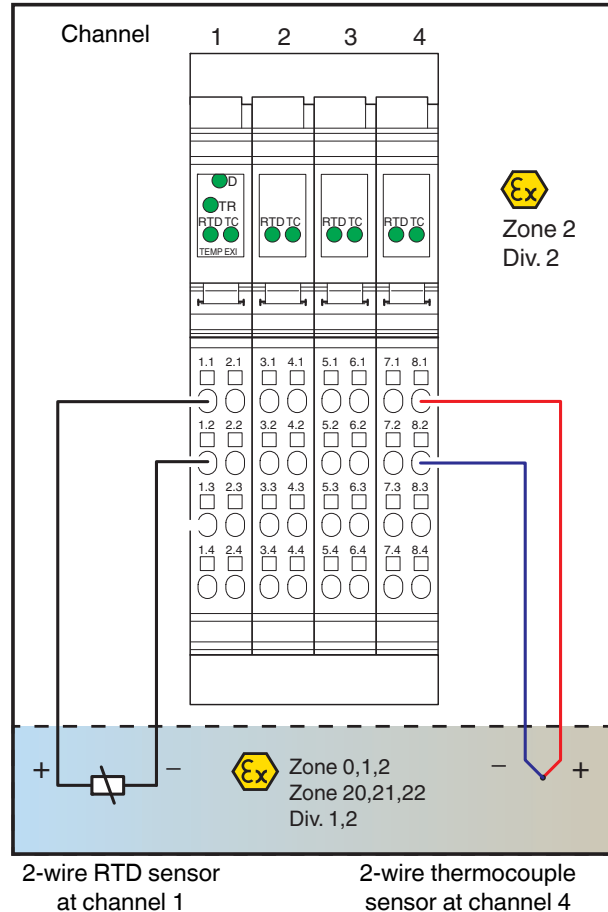

Figure 5 Connection of 2-wire RTD and thermocouple sensors

12 Configuration and analog values

You can either configure the device via process data or via PCP and transmit analog values accordingly.

If the device was configured via PCP, the configuration can no longer be modified the via process data.

13 Programming data/configuration data

13.1 INTERBUS

ID code	0xDF _{hex} (223 _{dec})
Length code	05 _{hex}
Process data channel	80 bits
Input address area	5 words
Output address area	5 words
Parameter channel (PCP)	1 word
Register length (bus)	6 words

13.2 Other bus systems



For the programming data/configuration data of other bus systems, please refer to the corresponding electronic device data sheet (e.g., GSD, EDS).

14 Process data

The device has 5 process data words and 1 PCP word. The first output word represents the control word because the assignment of the following words depends on the configuration. As confirmation for a control word action, the first input word contains a partial copy of the control word.

For device configuration, channel-specific configuration data is set in the relevant channel output words. Once configuration has been completed, and depending on the format set, the measured values in the corresponding input words are either transmitted to the controller board or to the computer.

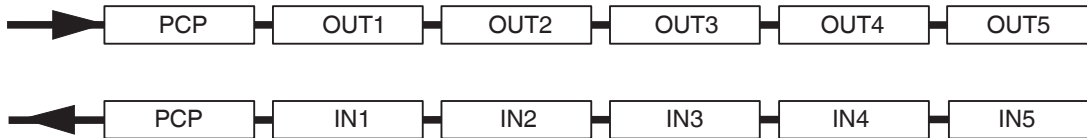

Figure 6 Order of the process data words

15 OUT process data words

15.1 Output word OUT1 (control word)

		OUT1															
		Byte 1							Byte 0								
Bit		15	14	13	12	11	10	9	8	7	6	5	4	3	2	1	0
Assignment		Command code 0x00							0	0	0	0	0	0	0	0	0

OUT1	Command description
0x4000	Configure device. The configuration parameters are sent on OUT2 to OUT5 for channel 1 to channel 4
0x1000	Read configuration one channel at a time Configuration for selected channel is displayed in IN2
0x1100	Read configuration for channel 1
0x1200	Read configuration for channel 2
0x1300	Read configuration for channel 3
0x1300	Read configuration for channel 4
0x0000	Read temperature values for all channels. Values are displayed on IN2 to IN5
0x3C00	Read device info – Firmware version and 4-bit device

15.2 Configuration via process data

		OUT1															
		Byte 1								Byte 0							
Bit		15	14	13	12	11	10	9	8	7	6	5	4	3	2	1	0
Assignment		Command code 0x40								0	0	0	0	0	0	0	0

		OUT2 to OUT5 and IN2 to IN5 for channel 1 to channel 4															
		Byte 1								Byte 0							
Bit		15	14	13	12	11	10	9	8	7	6	5	4	3	2	1	0
Assignment		0	Refresh rate	Wire	R0				Resolution	Format	Sensor type						

The values available for the different field types

		IN1																
		Byte 1								Byte 0								
Bit		15	14	13	12	11	10	9	8	7	6	5	4	3	2	1	0	
Assignment		EB	Mirrored command code							0	0	0	0	0	0	0	0	0

The default configuration is no sensors connected on any channel.

The selection of any reserved value in any field results in an error.

15.3 Read configuration via process data

		OUT1															
		Byte 1								Byte 0							
Bit		15	14	13	12	11	10	9	8	7	6	5	4	3	2	1	0
Assignment		Command code 0x00, 0x11, 0x12, 0x13								0	0	0	0	0	0	0	0

		IN1															
		Byte 1								Byte 0							
Bit		15	14	13	12	11	10	9	8	7	6	5	4	3	2	1	0
Assignment		Mirrored command code								0	0	0	0	0	0	0	0

		IN2															
		Byte 1								Byte 0							
Bit		15	14	13	12	11	10	9	8	7	6	5	4	3	2	1	0
Assignment		0	Filter time	Wire	R0				Resolution	Format	Sensor type						

IN2 to IN5 will be invalid and will contain value 0x0000

If there is a read configuration before first write configuration, the default configuration is returned.

Field	Value binary	Description		
Sensor type				
	00000	Pt DIN (default)		
	00001	Reserved		
	00010	Ni DIN		
	00011	Reserved		
	001xx	Reserved		
	010xx	Reserved		
	01100	Reserved		
	01101	Reserved		
	01110	Linear R 0 ... 800 Ω		
	01111	Linear R 0 ... 5 kΩ		
	10000	TC Type K		
	10001	TC Type J		
	10010	TC Type E		
	10011	TC Type R		
	10100	TC Type S		
	10101	TC Type T		
	1011x	Reserved		
	11101	Cold junction		
	11110	U Voltage ±100 mV		
	11111	Not connected		
Format				
	0	IB IL (default)		
	1	S7 Compatible		
Resolution		All sensors	Linear R 0-800	Linear R 0-5k
	00 (default)	0.1°C	0.1 Ω	1 Ω
	01	0.01°C	0.01 Ω	0.1 Ω
	10	0.1°F	Reserved	
	11	0.01°F	Reserved	
R0				
	0000	100 (default)		
	0001	10 (reserved)		
	0010	20 (reserved)		
	0011	30 (reserved)		
	0100	50 (reserved)		
	0101	120 (reserved)		
	0110	150 (reserved)		
	0111	200		
	1000	240 (reserved)		
	1001	300 (reserved)		
	1010	400 (reserved)		
	1011	500		

Field	Value binary	Description
	1100	1000
	1101	1500 (reserved)
	1110	2000 (reserved)
	1111	5000
Wire		
	0	2-wire (default)
	1	3-wire
Filter Time		
	00	480 ms (default)
	01	120 ms
	10	100 ms
	11	200 ms

15.4 Read temperature values via process data

		OUT1															
		Byte 1								Byte 0							
Bit	Assignment	15	14	13	12	11	10	9	8	7	6	5	4	3	2	1	0
		Command code 0x00								0	0	0	0	0	0	0	0

		IN1															
		Byte 1								Byte 0							
Bit	Assignment	15	14	13	12	11	10	9	8	7	6	5	4	3	2	1	0
		Mirrored command code 0x00								0	0	0	0	0	0	0	0

		IN2 to IN5 for channel 1 to channel 4															
		Byte 1								Byte 0							
Bit	Assignment	15	14	13	12	11	10	9	8	7	6	5	4	3	2	1	0
	Sign bit	Temperature value in selected format															

Only temperature values corresponding to configured channels are processed.

In case of a read temperature value on unconfigured channels, the returned value will be in accordance with the selected representation format, i.e., 0x8004 (IB IL) or 0x8000 (S7).

15.5 Read device information via process data

		OUT1															
		Byte 1								Byte 0							
Bit	Assignment	15	14	13	12	11	10	9	8	7	6	5	4	3	2	1	0
		Command code 0x3C								0	0	0	0	0	0	0	0

		IN1															
		Byte 1								Byte 0							
Bit	Assignment	15	14	13	12	11	10	9	8	7	6	5	4	3	2	1	0
		Mirrored command code 0x3C								0	0	0	0	0	0	0	0

		IN2															
		Byte 1								Byte 0							
Bit		15	14	13	12	11	10	9	8	7	6	5	4	3	2	1	0
Assignment		Firmware version 1.00											Device ID 0x3				

16 Formats for the representation of measured values (IN2 to IN5)

16.1 Format: "IB IL" (default setting)

The measured value is represented in bits 14 to 0. An additional bit (bit 15) is available as a sign bit.

This format supports extended diagnostics. Values > 8000_{hex} and < 8100_{hex} indicate an error. The error codes are listed on page 16.

		IN2 to IN5 for channel 1 to channel 4															
		Byte 1								Byte 0							
Bit		15	14	13	12	11	10	9	8	7	6	5	4	3	2	1	0
Assignment	SB	Analog value in IB IL format															

Significant measured values

Input measuring range

IB input word	All temperature sensors		R0 up to 800 Ω		R0 up to 5000 Ω	
	0.1°C	0.01°C	0.1 Ω	0.01 Ω	1.0 Ω	0.1 Ω
8001 over range	> Limit value	> 327	> 800	> 80	> 5000	> 500
0FA0	400	40	400	40	4000	400
0001	0.1	+0.01	0.1	+0.01	1.0	+0.1
0000	≤ 0	0	≤0	≤0	≤0	≤0
FFFF	-0.1	-0.01	NA ¹	NA ¹	NA ¹	NA ¹
FC18	-100	-10	NA ¹	NA ¹	NA ¹	NA ¹
8080 under range	<limit value	<limit value	NA ¹	NA ¹	NA ¹	NA ¹

¹ Returns "measure value invalid/channel disabled (error code 8004)

Supported error codes

Input data word (hex)	Error
8001	Overrange
8002	Open circuit/broken wire
8004	Measured value invalid/channel disabled
8010	Invalid configuration
8020	I/O supply voltage fault
8040	Device fault
8080	Underrange

16.2 Format: “S7-Compatible”

The measured value is represented in bits 14 to 0. An additional bit (bit 15) is available as a sign bit.

Measured value representation in “S7-compatible” format

MSB														LSB	
15	14	13	12	11	10	9	8	7	6	5	4	3	2	1	0
SB	Analog value in S7 format														

Significant measured values

IB input word	All temperature sensors		R0 up to 800 Ω		R0 up to 5000 Ω	
	0.1 °C	0.01 °C	0.1 Ω	0.01 Ω	1.0 Ω	0.1 Ω
7FFF over range	> Limit value	> 327	> 800	> 80	> 5000	> 500
0FA0	400	40	400	40	4000	400
0001	0.1	+0.01	0.1	+0.01	1.0	+0.1
0000	≤ 0	0	≤0	≤0	≤0	≤0
FFFF	-0.1	-0.01	NA ¹	NA ¹	NA ¹	NA ¹
FC18	-100	-10	NA ¹	NA ¹	NA ¹	NA ¹
8000 under range	<limit value	<limit value	NA ¹	NA ¹	NA ¹	NA ¹

¹ Returns “measure value invalid/channel disabled (error code 8004)”

Supported error codes

Input data word (hex)	Error
7FFF	Overrange
8002	Open circuit/broken wire
8004	Measured value invalid/channel disabled
8010	Invalid configuration
8020	I/O supply voltage fault
8040	Device fault
8080	Underrange

17 PCP communication



For information on PCP communication, please refer to the IBS SYS PCP G4 UM E (Order No. 2745169) and IBS PCP COMPACT UM E (Order No. 9015349) user manuals.

By default, the IB IL EX-IS TEMP 4 RTD/TC-PAC is configured to the default settings. The module can be configured via process data or PCP to adapt to a particular application. In PCP mode, the device is configured with the “Config Table” object.



The IBS CMD (for standard controller boards) and PC WorX (for Field Controllers (FC) and Remote Field Controllers (RFC)) programs are available for the configuration and parameterization of your INTERBUS system. For additional information, please refer to the “IBS CMD SWT G4 UM E” (Order No. 2722250) user manual and the documentation for your applied PC WorX version.

PCP can be used to:

- identify the device
- configure the device
- read temperature values from channels
- calibrate the device
- get diagnostic information
- channel scout

17.1 Object dictionary

Index	Data type	Length	Meaning	Object name	Rights
01	Visible string	58 max. bytes	Phoenix Contact GmbH & Co. Kg	VendorName	R
02	Visible string	6 bytes	Vendor ID 000A45	VendorID	R
04	Visible string	58 max. bytes	Device family	DeviceFamily	R
06	Visible string	58 max. bytes	Product family "INLINE"	ProductFamily	R
07	Visible string	58 max. bytes	IB IL EX-IS TEMP 4 RTD/TC-PAC	ProductName	R
09	Visible string	58 max. bytes	Intrinsically safe temperature module	ProductText	R
0A	Visible string	58 max. bytes	2869913	OrderNumber	R
0B	Visible string	58 max. bytes	YYYY-MM-DD Hardware Version	HardwareVersion	R
0C	Visible string	58 max. bytes	YYYY-MM-DD Firmware Version	FirmwareVersion	R
0D	Record	2 fields	YYYY-MM-DD PCP Compact Version	PCPVersion	R
0E	Visible string	3 bytes	633	CommProfile	R
11	Record	2 fields	YYYY-MM-DD Basic Profile Version	ProfileVersion	R
12	Visible string	58 max. bytes	URL http:// www.phoenixcontact.com	VendorURL[]	R
17	Record	2 fields	Language English	Language	R
25	Octet string	5 units	IN Process Data	PDIN	R
26	Octet String	5 units	OUT Process Data	PDOOUT	R
32	Record	2 fields	ID_code and PD length	IBS_ID	R
3A	Array	4 fields	VersionCount	VersionCount	R
80	Visible string	58 max. bytes	Hardware Version	Config table	R/W
81	16-bit array, unsigned		Input data	Temperature values	R
18	Record		Diagnostic status	DiagState	R

17.2 Configuration via PCP

Config table object

The Configuration Table object can be used for configuring the module using PCP compact. Following are the Index and Subindex fields along with their respective descriptions.

Object	Config table	
Access	Read, write	
Data type	16-bit array, unsigned	
Index (hex)	0080	
Subindex (hex)	00	Configure device all channels
	01	Configure channel 1
	02	Configure channel 2
	03	Configure channel 3
	04	Configure channel 4
Length	08	Subindex 00
	02	Subindex 01 to 04

For subindex 0 to 4, configuration data is per channel (same as configuration by process data).

OUT2 to OUT5 and IN2 to IN5 for channel 1 to channel 4																
Byte 1								Byte 0								
Bit	15	14	13	12	11	10	9	8	7	6	5	4	3	2	1	0
Assignment	0		Refresh rate	Wire	R0			Resolution	Format	Sensor type						

17.3 Temperature values object

This object can be used for reading 16-bit temperature values from the configured input channels.

Object	Temperature IN values	
Access	Read	
Data type	16-bit array, unsigned	
Index (hex)	0081	
Subindex (hex)	00	Read all channels
	01	Read temperature value channel 1
	02	Read temperature value channel 2
	03	Read temperature value channel 3
	04	Read temperature value channel 4
Length (bytes, hex)	08	Subindex 00
	02	Subindex 01 to 04
Data	Channel temperature values	

Channel analog values

MSB															LSB
15	14	13	12	11	10	9	8	7	6	5	4	3	2	1	0
SB	Temperature value in selected format														

17.4 DiagState object

This object can be used to obtain the diagnostics from the IB IL EX-IS TEMP 4 RTD/TC-PAC module in the standard format. Useful information, like the number of errors occurred, brief description text, channel number, etc., for the error and error code can be obtained using this object.

Object	DiagState	
Access	Read	
Data type	Record	
Index (hex)	0018	
Subindex (hex)	00	Read all channels
	01	Total count of number of errors occurred Resets to 0 when full
	02	Priority U8 0x00 - no error occurred 0x02 - any error
	03	Channel U8 channel number for last occurred error
	04	Error code U16 error code from basic profile Always shows last error code
	05	More follows: U8 always 0x00
	06	Text 10 bytes: Text equivalent of supported error codes
Length (bytes, hex)	11	Subindex 00 length
	02	Subindex 01 length
	01	Subindex 02 length
	01	Subindex 03 length
	02	Subindex 04 length
	01	Subindex 05 length
	0A	Subindex 06 length
Data	As specified above	

Supported error codes

Error code (hex)	Error
0x0000	OK
0x6320	Invalid configuration
0x6330	Invalid data
0x8910	Overrange
0x8920	Underrange
0x7790	Broken wire
0x5160	No power for I/O section
0x5010	Hardware failure - note - code checksum