



EPAD® LOW POWER CMOS OPERATIONAL AMPLIFIER

KEY FEATURES

- EPAD (Electrically Programmable Analog Device)
- User programmable V_{OS} trimmer
- Computer-assisted trimming
- Rail-to-rail input/output
- Compatible with standard EPAD Programmer
- High precision through in-system circuit precision trimming
- Reduces or eliminates V_{OS} , PSRR, CMRR and TCV_{OS} errors
- System level “calibration” capability
- Application Specific Programming mode
- In-System Programming mode
- Electrically programmable to compensate for external component tolerances
- Achieves 0.01pA input bias current and 25 μ V input offset voltage simultaneously
- Compatible with industry standard pinout

GENERAL DESCRIPTION

The ALD1722E is a monolithic rail-to-rail precision CMOS operational amplifier with integrated user programmable EPAD (Electrically Programmable Analog Device) based offset voltage adjustment. The ALD1722E is a direct replacement of the ALD1712 operational amplifier, with the added feature of user-programmable offset voltage trimming resulting in significantly enhanced total system performance and user flexibility. EPAD technology is an exclusive ALD design which has been refined for analog applications where precision voltage trimming is necessary to achieve a desired performance. It utilizes CMOS FETs as in-circuit elements for trimming of offset voltage bias characteristics with the aid of a personal computer under software control. Once programmed, the set parameters are stored indefinitely within the device even after power-down. EPAD offers the circuit designer a convenient and cost-effective trimming solution for achieving the very highest amplifier/system performance.

The ALD1722E operational amplifier features rail-to-rail input and output voltage ranges, tolerance to over-voltage input spikes of 300mV beyond supply rails, high capacitive loading up to 4000pF, extremely low input currents of 0.01pA typical, high open loop voltage gain, useful bandwidth of 1.5MHz, slew rate of 2.1V/ μ s, and low supply current of 0.8mA.

ORDERING INFORMATION (“L” suffix denotes lead-free (RoHS))

Operating Temperature Range		
0°C to +70°C	0°C to +70°C	-55°C to +125°C
8-Pin Small Outline Package (SOIC)	8-Pin Plastic Dip Package	8-Pin CERDIP Package
ALD1722ESAL	ALD1722EPAL	ALD1722EDA

* Contact factory for leaded (non-RoHS) or high temperature versions.

BENEFITS

- Eliminates manual system trimming
- Drive up to 4000pF load capacitance
- Remote controlled automated trimming
- In-System Programming capable
- Industry standard pinout
- Rail-to-rail input/output
- Input bias current of 0.01pA and input offset voltage of 25 μ V
- No external components
- No internal chopper clocking noise
- No chopper dynamic power dissipation
- Simple and cost effective
- Small package size
- Low power

APPLICATIONS

- Sensor interface circuits
- Unity gain buffer amplifier
- Precision analog cable driver
- Transducer biasing circuits
- Capacitive and charge integration circuits
- Biochemical probe interface
- Signal conditioning
- Portable instruments
- High source impedance electrode amplifiers
- Precision Sample and Hold amplifiers
- Precision current to voltage converter
- Error correction circuits
- Sensor compensation circuits
- Precision gain amplifiers
- Current sources
- Periodic In-system calibration
- System output level shifter

PIN CONFIGURATION

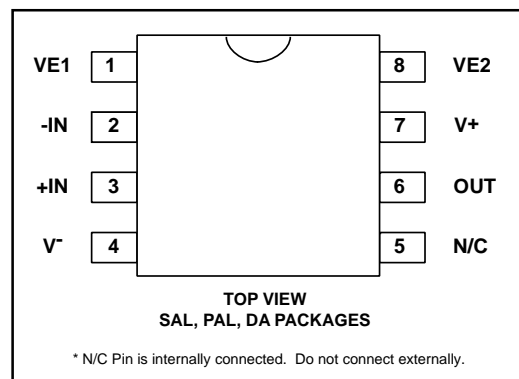

FUNCTIONAL DESCRIPTION

The ALD1722E uses EPADs as in-circuit elements for trimming of offset voltage bias characteristics. Each ALD1722E has a pair of EPAD-based circuits connected such that one circuit is used to adjust V_{OS} in one direction and the other circuit is used to adjust V_{OS} in the other direction. While each of the EPAD devices is a monotonically adjustable programmable device, the V_{OS} of the ALD1722E can be adjusted many times in both directions. Once programmed, the set V_{OS} levels are stored permanently, even when the device power is removed.

The ALD1722E is pre-programmed at the factory under standard operating conditions for minimum equivalent input offset voltage. It also has a guaranteed offset voltage program range, which is ideal for applications that require electrical offset voltage programming.

The ALD1722E is an operational amplifier that can be trimmed with user application-specific programming or in-system programming conditions. User application-specific circuit programming refers to the situation where the Total Input Offset Voltage of the ALD1722E can be trimmed with the actual intended operating conditions.

For example, an application circuit may have +6V and -2.5V power supplies, and the operational amplifier input is biased at +0.7V, and an average operating temperature at 55°C. The circuit can be wired up to these conditions within an environmental chamber with the ALD1722E inserted into a test socket connected to this circuit while it is being electrically trimmed. Any error in V_{OS} due to these bias conditions can be automatically zeroed out. The Total V_{OS} error is now limited only by the adjustable range and the stability of V_{OS} , and the input noise voltage of the operational amplifier. Therefore, this Total V_{OS} error now includes V_{OS} as V_{OS} is traditionally specified; plus the V_{OS} error contributions from PSRR, CMRR, TCV_{OS} , and noise. Typically this total V_{OS} error term (V_{OST}) is approximately $\pm 25\mu V$ for the ALD1722E.

The V_{OS} contribution due to PSRR, CMRR, TCV_{OS} and external components can be large for operational amplifiers without trimming. Therefore the ALD1722E with EPAD trimming is able to provide much improved system performance by reducing these other sources of error to provide significantly reduced V_{OST} .

In-System Programming refers to the condition where the EPAD adjustment is made after the ALD1722E has been inserted into a circuit board. In this case, the circuit design must provide for the ALD1722E to operate in normal mode and in programming mode. One of the benefits of in-system programming is that not only is the ALD1722E offset voltage from operating bias conditions accounted for, any residual errors introduced by other circuit components, such as resistor or sensor induced voltage errors, can also be corrected. In this way, the "in-system" circuit output can be adjusted to a desired level, eliminating the need for another trimming function.

USER PROGRAMMABLE V_{OS} FEATURE

Each ALD1722E has two pins named VE1 and VE2 which are internally connected to an internal offset bias circuit. VE1/VE2 have initial typical values of 1.6V. The voltage on these pins can be programmed using the ALD E100 EPAD Programmer and the appropriate Adapter Module. The useful programming range of VE1 and VE2 is 1.6V to 3.5V.

VE1 and VE2 pins are programming pins, used during programming mode to inject charge into the internal EPADs. Increasing voltage on VE1 decreases the offset voltage whereas increasing voltage on VE2 increases the offset voltage of the operational amplifier. The injected charge is permanently stored and determines the offset voltage of the operational amplifier. After programming, VE1 and VE2 terminals must be left open to settle on a voltage determined by internal bias currents.

During programming, the voltages on VE1 or VE2 are increased incrementally to set the offset voltage of the operational amplifier to the desired V_{OS} . Note that desired V_{OS} can be any value within the offset voltage programmable ranges, and can be zero, a positive value or a negative value. This V_{OS} value can also be reprogrammed to a different value at a later time, provided that the useful VE1 or VE2 programming voltage range has not been exceeded. VE1 or VE2 pins can also serve as capacitively coupled input pins.

Internally, VE1 and VE2 are programmed and connected differentially. Temperature drift effects between the two internal offset bias circuits cancel each other and introduce less net temperature drift coefficient change than offset voltage trimming techniques such as offset adjustment with an external trimmer potentiometer.

While programming, $V+$, VE1 and VE2 pins may be alternately pulsed with 12V (approximately) pulses generated by the EPAD Programmer. In-system programming requires the ALD1722E application circuit to accommodate these programming pulses. This can be accomplished by adding resistors at certain appropriate circuit nodes. For more information, see Application Note AN1700.

ABSOLUTE MAXIMUM RATINGS

Supply voltage, V+ _____ 10.6V
 Differential input voltage range _____ -0.3V to V+ +0.3V
 Power dissipation _____ 600 mW
 Operating temperature range SAL, PAL packages _____ 0°C to +70°C
 DA package _____ -55°C to +125°C
 Storage temperature range _____ -65°C to +150°C
 Lead temperature, 10 seconds _____ +260°C

CAUTION: ESD Sensitive Device. Use static control procedures in ESD controlled environment.

OPERATING ELECTRICAL CHARACTERISTICS

T_A = 25°C V_S = ±2.5V unless otherwise specified

Parameter	Symbol	ALD1722E			Unit	Test Conditions
		Min	Typ	Max		
Supply Voltage	V _S	±2.0		±5.0	V	Single Supply
	V+	4.0		10.0	V	
Initial Input Offset Voltage ¹	V _{OSi}		25	90	μV	R _S ≤ 100KΩ
Offset Voltage Program Range ²	ΔV _{OS}	±5	±8		mV	
Programmed Input Offset Voltage Error ³	V _{OS}		25	50	μV	At user specified target offset voltage
Total Input Offset Voltage ⁴	V _{OSt}		25	50	μV	At user specified target offset voltage
Input Offset Current ⁵	I _{OS}		0.01	10	pA	T _A = 25°C 0°C ≤ T _A ≤ +70°C
				280		
Input Bias Current ⁵	I _B		0.01	10	pA	T _A = 25°C 0°C ≤ T _A ≤ +70°C
				280		
Input Voltage Range ⁶	V _{IR}	-0.3		5.3	V	V+ = +5V; notes 2,5 V _S = ±2.5V
		-2.8		+2.8		
Input Resistance	R _{IN}		10 ¹⁴		Ω	
Input Offset Voltage Drift ⁷	TCV _{OS}		5		μV/°C	R _S ≤ 100KΩ
Initial Power Supply Rejection Ratio ⁸	PSRR _i		85		dB	R _S ≤ 100KΩ
Initial Common Mode Rejection Ratio ⁸	CMRR _i		97		dB	R _S ≤ 100KΩ
Large Signal Voltage Gain	A _V	50	250		V/mV	R _L = 10KΩ R _L ≥ 1MΩ
			500		V/mV	
Output Voltage Range	V _O low	4.99	0.002	0.01	V	R _L = 1MΩ V+ = 5V 0°C ≤ T _A ≤ +70°C
	V _O high		4.998		V	
	V _O low	2.35	-2.44	-2.35	V	R _L = 10KΩ 0°C ≤ T _A ≤ +70°C
	V _O high		2.44		V	
Output Short Circuit Current	I _{SC}		8		mA	

* NOTES 1 through 9, see "Definitions and Design Notes" on page 6.

OPERATING ELECTRICAL CHARACTERISTICS (cont'd)

$T_A = 25^\circ\text{C}$ $V_S = \pm 2.5\text{V}$ unless otherwise specified

Parameter	Symbol	1722E			Unit	Test Conditions
		Min	Typ	Max		
Supply Current No Load	I_S		0.8	1.5	mA	$V_{IN} = 0\text{V}$
Power Dissipation	P_D		4.0	7.5	mW	$V_S = \pm 2.5\text{V}$
Input Capacitance	C_{IN}		1		pF	
Maximum Load Capacitance	C_L		400 4000		pF pF	Gain = 1 Gain = 5
Input Noise Voltage	e_n		26		$\text{nV}/\sqrt{\text{Hz}}$	$f = 1\text{KHz}$
Input Current Noise	i_n		0.6		$\text{fA}/\sqrt{\text{Hz}}$	$f = 10\text{Hz}$
Bandwidth	B_W	1.0	1.5		MHz	
Slew Rate	S_R	1.4	2.1		$\text{V}/\mu\text{s}$	$A_V = +1$ $R_L = 10\text{K}\Omega$
Rise time	t_r		0.2		μs	$R_L = 10\text{K}\Omega$
Overshoot Factor			10		%	$R_L = 10\text{K}\Omega$, $C_L = 100\text{pF}$
Settling Time	t_s		8.0 3.0		μs μs	0.01% 0.1% $A_V = -1$, $R_L = 5\text{K}\Omega$ $C_L = 50\text{pF}$

$T_A = 25^\circ\text{C}$ $V_S = \pm 2.5\text{V}$ unless otherwise specified

Parameter	Symbol	1722E			Unit	Test Conditions
		Min	Typ	Max		
Average Long Term Input Offset Voltage Stability ⁹	$\frac{\Delta V_{OS}}{\Delta \text{time}}$		0.02		$\mu\text{V}/$ 1000 hrs	
Initial VE Voltage	$VE1_i$ $VE2_i$		1.6		V	
Programmable VE Range	$\Delta VE1$ $\Delta VE2$	1.5	2.0		V	
VE Pin Leakage Current	i_{eb}		-5		μA	

OPERATING ELECTRICAL CHARACTERISTICS (cont'd)

$V_S = \pm 2.5V$ $-55^\circ C \leq T_A \leq +125^\circ C$ unless otherwise specified

Parameter	Symbol	1722E			Unit	Test Conditions
		Min	Typ	Max		
Initial Input Offset Voltage	V_{OSi}		0.5		mV	$R_S \leq 100K\Omega$
Input Offset Current	I_{OS}			2.0	nA	
Input Bias Current	I_B			2.0	nA	
Initial Power Supply Rejection Ratio ⁸	$PSRR_i$		85		dB	$R_S \leq 100K\Omega$
Initial Common Mode Rejection Ratio ⁸	$CMRR_i$		97		dB	$R_S \leq 100K\Omega$
Large Signal Voltage Gain	A_V	10	25		V/mV	$R_L \leq 10K\Omega$
Output Voltage Range	$V_{O\ low}$ $V_{O\ high}$	2.3	-2.4 2.4	-2.3	V V	$R_L \leq 10K\Omega$

$T_A = 25^\circ C$ $V_S = \pm 5.0V$ unless otherwise specified

Parameter	Symbol	1722E			Unit	Test Conditions
		Min	Typ	Max		
Initial Power Supply Rejection Ratio ⁸	$PSRR_i$		85		dB	$R_S \leq 100K\Omega$
Initial Common Mode Rejection Ratio ⁸	$CMRR_i$		97		dB	$R_S \leq 100K\Omega$
Large Signal Voltage Gain	A_V		250		V/mV	$R_L = 10K\Omega$
Output Voltage Range	$V_{O\ low}$ $V_{O\ high}$	4.80	-4.90 4.93	-4.80	V	$R_L = 10K\Omega$
Bandwidth	B_W		1.7		MHz	
Slew Rate	S_R		2.8		V/ μs	$A_V = +1$, $C_L = 50pF$

DEFINITIONS AND DESIGN NOTES:

1. Initial Input Offset Voltage is the initial offset voltage of the ALD1722E operational amplifier when shipped from the factory. The device has been pre-programmed and tested for programmability.
2. Offset Voltage Program Range is the range of adjustment of user specified target offset voltage. This is typically an adjustment in either the positive or the negative direction of the input offset voltage from an initial input offset voltage. The input offset programming pins, VE1 or VE2, change the input offset voltage in the negative or positive direction, respectively. User specified target offset voltage can be any offset voltage within this programming range.
3. Programmed Input Offset Voltage Error is the final offset voltage error after programming when the Input Offset Voltage is at target Offset Voltage. This parameter is sample tested.
4. Total Input Offset Voltage is the same as Programmed Input Offset Voltage, corrected for system offset voltage error. Usually this is an all inclusive system offset voltage, which also includes offset voltage contributions from input offset voltage, PSRR, CMRR, TCV_{OS} and noise. It can also include errors introduced by external components, at a system level. Programmed Input Offset Voltage and Total Input Offset Voltage is not necessarily zero offset voltage, but an offset voltage set to compensate for other system errors as well. This parameter is sample tested.
5. The Input Offset and Bias Currents are essentially input protection diode reverse bias leakage currents. This low input bias current assures that the analog signal from the source will not be distorted by it. For applications where source impedance is very high, it may be necessary to limit noise and hum pickup through proper shielding.
6. Input Voltage Range is determined by two parallel complementary input stages that are summed internally, each stage having a separate input offset voltage. While Total Input Offset Voltage can be trimmed to a desired target value, it is essential to note that this trimming occurs at only one user selected input bias voltage. Depending on the selected input bias voltage relative to the power supply voltages, offset voltage trimming may affect one or both input stages. For the ALD1722E, the switching point between the two stages occurs at approximately 1.5V above negative supply voltage.
7. Input Offset Voltage Drift is the average change in Total Input Offset Voltage as a function of ambient temperature. This parameter is sample tested.
8. Initial PSRR and initial CMRR specifications are provided as reference information. After programming, error contribution to the offset voltage from PSRR and CMRR is set to zero under the specific power supply and common mode conditions, and becomes part of the Programmed Input Offset Voltage Error.
9. Average Long Term Input Offset Voltage Stability is based on input offset voltage shift through operating life test at 125°C extrapolated to $T_A = 25^\circ\text{C}$, assuming activation energy of 1.0eV. This parameter is sample tested.

ADDITIONAL DESIGN NOTES:

- A. The ALD1722E is internally compensated for unity gain stability using a novel scheme which produces a single pole roll off in the gain characteristics while providing more than 70 degrees of phase margin at unity gain frequency. A unity gain buffer using the ALD1722E will typically drive 400pF of external load capacitance; in the inverting unity gain configuration, it can drive up to 800pF of load capacitance. At a gain of 5, the ALD1722E can drive up to 4000pF load capacitance, and is ideally suited for high precision analog signal transmitted across a cable or a wiring harness applications.
- B. The ALD1722E has complementary p-channel and n-channel input differential stages connected in parallel to accomplish rail to rail input common mode voltage range. The switching point between the two differential stages is 1.5V above negative supply voltage. For applications such as inverting amplifiers or non-inverting amplifiers with a gain larger than 2.5 (5V operation), the common mode voltage does not make excursions below this switching point.
- C. The output stage consists of class AB complementary output drivers. The oscillation resistant feature, combined with the rail-to-rail input and output feature, makes the ALD1722E an effective analog signal buffer for high source impedance sensors, transducers, and other circuit networks.
- D. The ALD1722E has static discharge protection. However, care must be exercised when handling the device to avoid strong static fields that may degrade a diode junction, causing increased input leakage currents. The user is advised to power up the circuit before, or simultaneously with, any input voltages applied and to limit input voltages not to exceed 0.3V of the power supply voltage levels.
- E. VE1 and VE2 are high impedance terminals, as the internal bias currents are set very low to a few microamperes to conserve power. For some applications, these terminals may need to be shielded from external noise coupling sources. For example, digital signals running nearby may cause unwanted offset voltage fluctuations. Care during the printed circuit board layout, to place ground traces around these pins and to isolate them from digital lines, will generally eliminate such coupling effects. In addition, optional decoupling capacitors of 1000pF or greater value can be added to VE1 and VE2 terminals.
- F. The ALD1722E is designed for use in low voltage, low power circuits. The maximum operating voltage during normal operation should remain below 10V at all times. Care should be taken to insure that the application in which the device is used does not experience any positive or negative transient voltages that cause any of the terminal voltages to exceed this limit.
- G. All inputs or unused pins except VE1 and VE2 pins should be connected to a supply voltage such as Ground so that they do not become floating pins, since input impedance at these pins is very high. If any of these pins are left undefined, they may cause unwanted oscillation or intermittent excessive current drain. As these devices are built with CMOS technology, normal operating and storage temperature limits, ESD and latchup handling precautions pertaining to CMOS device handling should be observed.

TYPICAL PERFORMANCE CHARACTERISTICS

COMMON MODE INPUT VOLTAGE RANGE AS A FUNCTION OF SUPPLY VOLTAGE

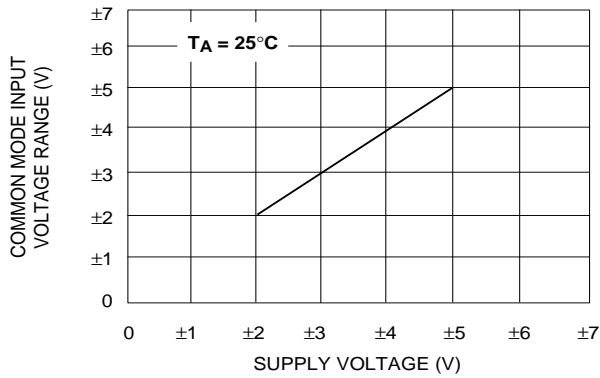

OPEN LOOP VOLTAGE GAIN AS A FUNCTION OF SUPPLY VOLTAGE AND TEMPERATURE

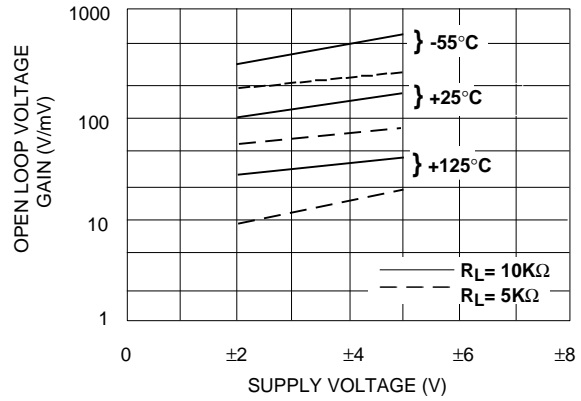

INPUT BIAS CURRENT AS A FUNCTION OF AMBIENT TEMPERATURE

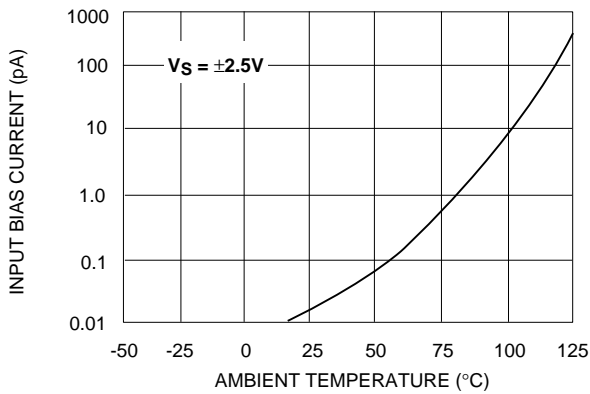

SUPPLY CURRENT AS A FUNCTION OF SUPPLY VOLTAGE

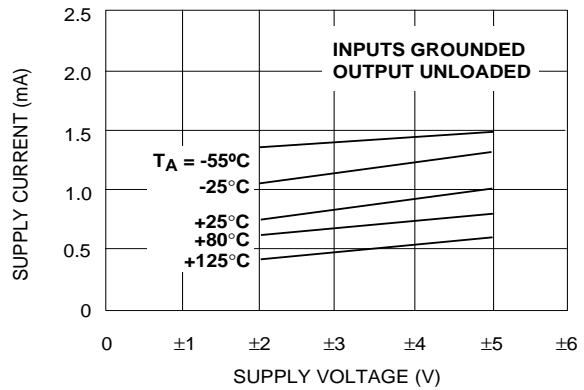

ADJUSTMENT IN INPUT OFFSET VOLTAGE AS A FUNCTION OF CHANGE IN VE1 AND VE2

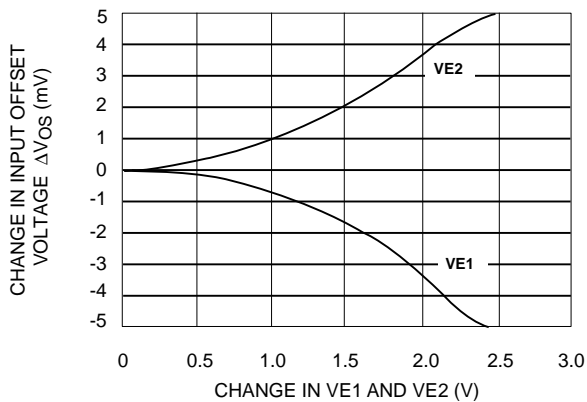

OPEN LOOP VOLTAGE AS A FUNCTION OF FREQUENCY

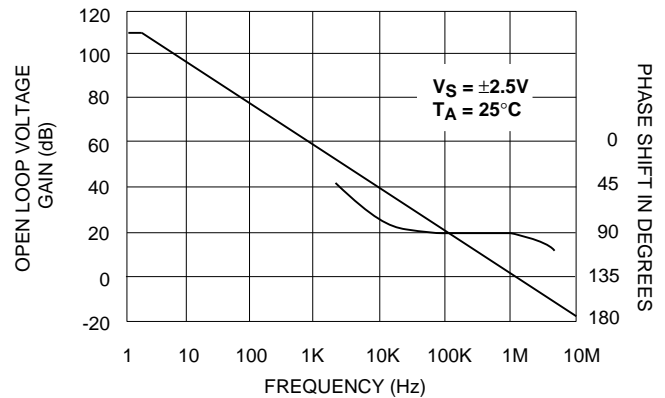

TYPICAL PERFORMANCE CHARACTERISTICS (cont'd)

OUTPUT VOLTAGE SWING AS A FUNCTION OF SUPPLY VOLTAGE

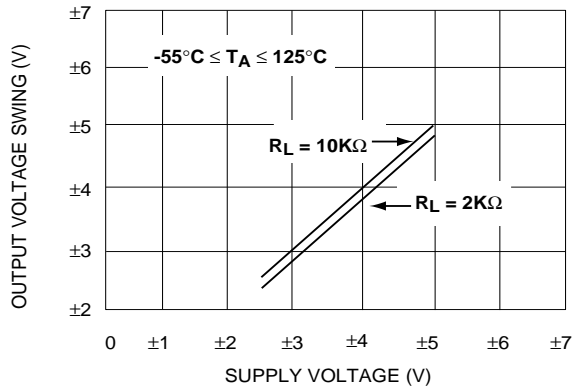

LARGE - SIGNAL TRANSIENT RESPONSE

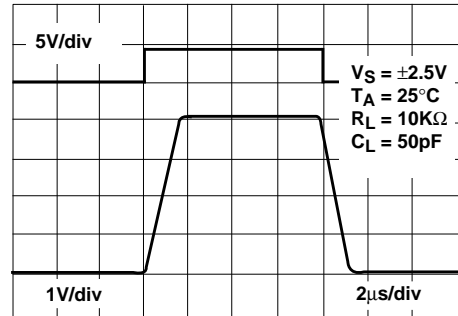

OPEN LOOP VOLTAGE GAIN AS A FUNCTION OF LOAD RESISTANCE

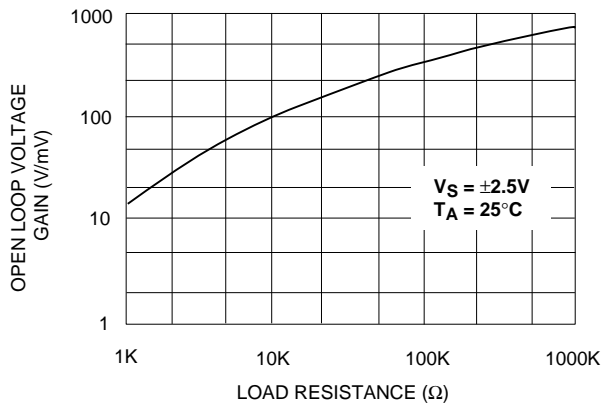

SMALL - SIGNAL TRANSIENT RESPONSE

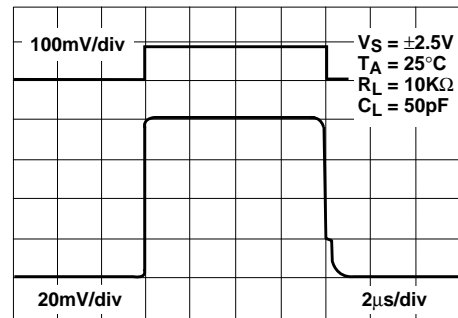

DISTRIBUTION OF TOTAL INPUT OFFSET VOLTAGE BEFORE AND AFTER EPAD PROGRAMMING

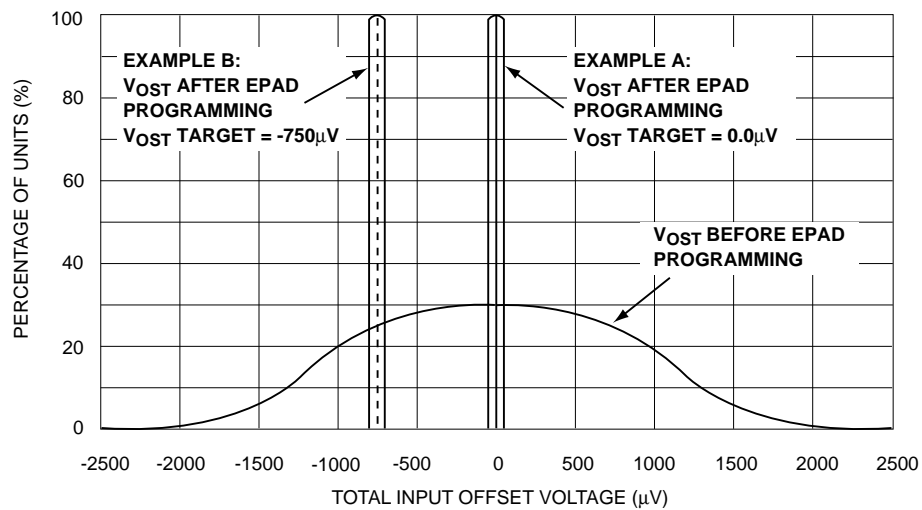

TYPICAL PERFORMANCE CHARACTERISTICS (cont'd)

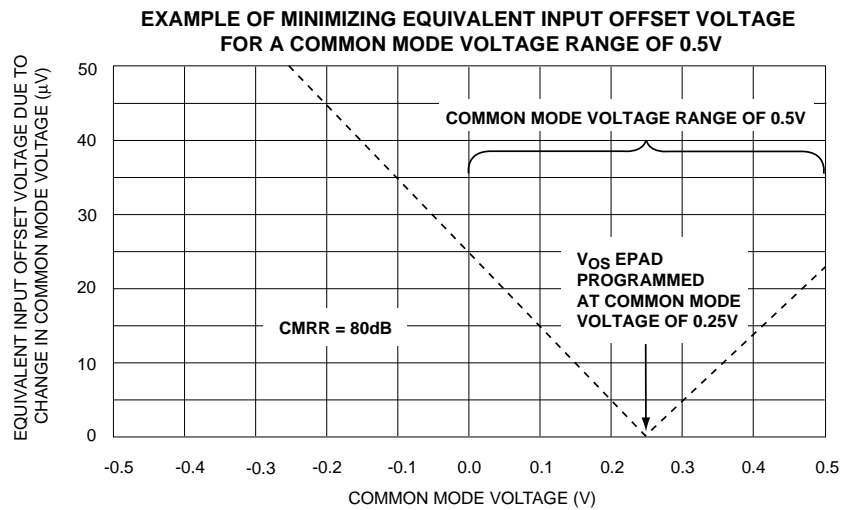
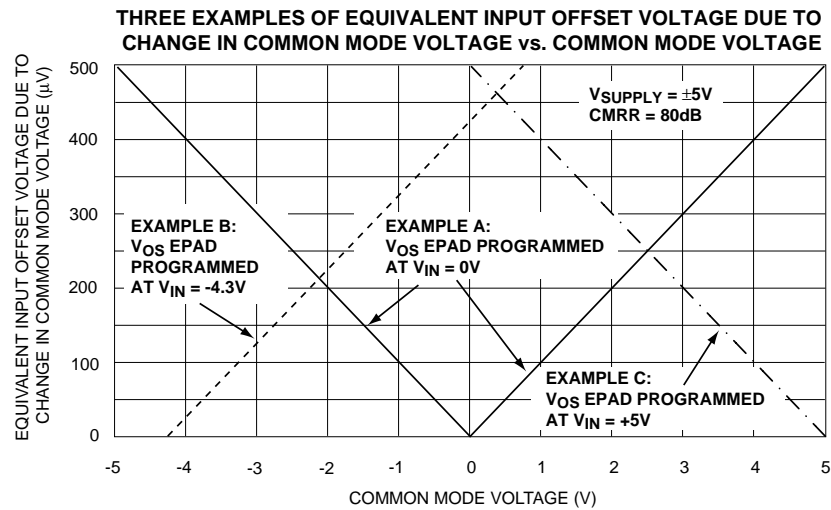
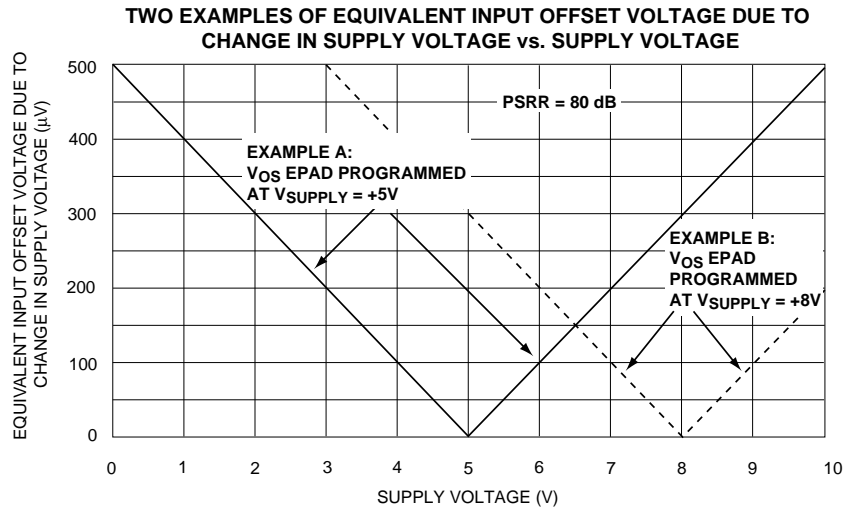

TYPICAL PERFORMANCE CHARACTERISTICS (cont'd)

APPLICATION SPECIFIC / IN-SYSTEM PROGRAMMING

Examples of applications where accumulated total input offset voltage from various contributing sources is minimized under different sets of user-specified operating conditions

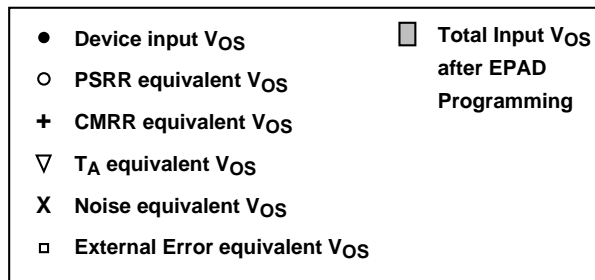
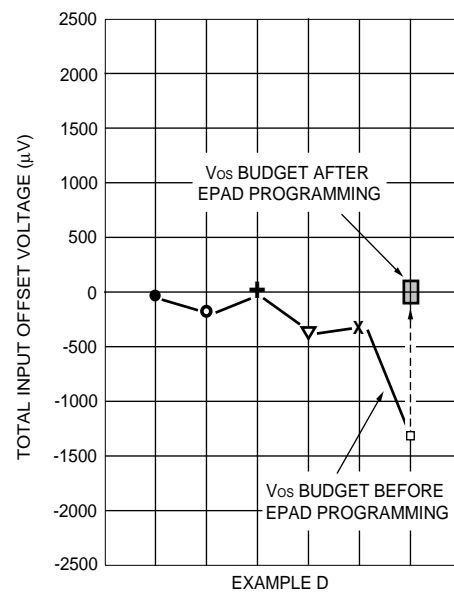
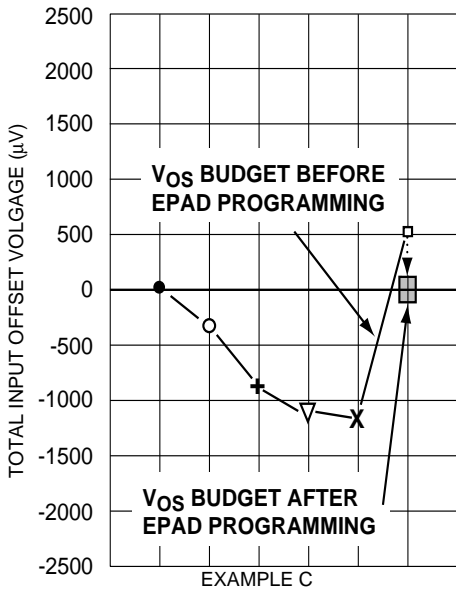
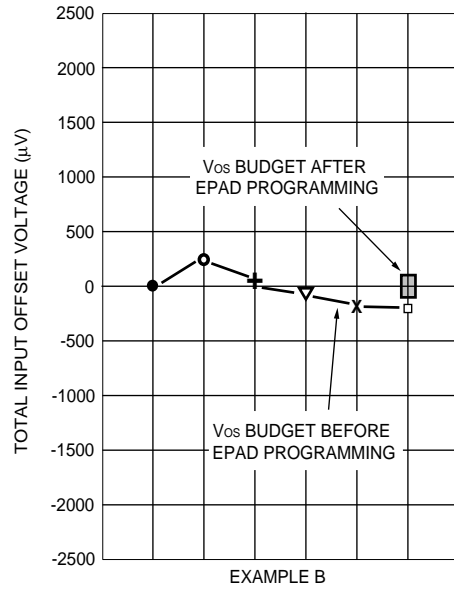
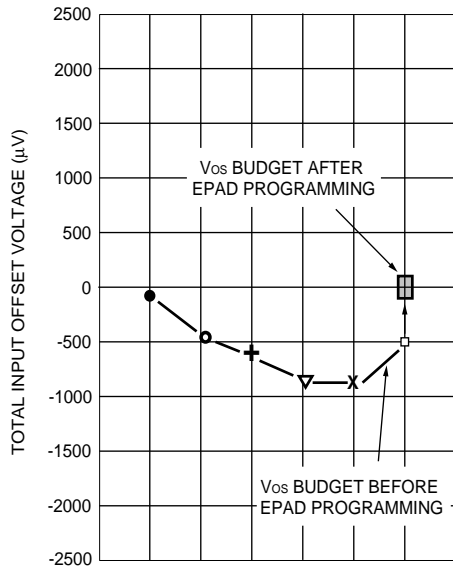

SOIC-8 PACKAGE DRAWING

8 Pin Plastic SOIC Package

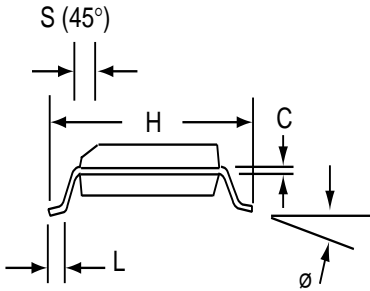
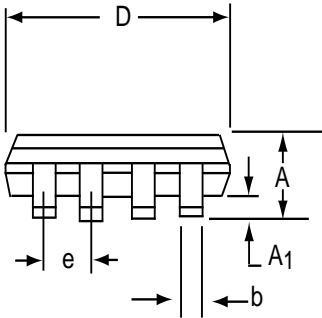
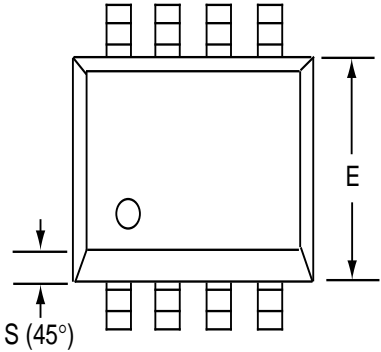

Dim	Millimeters		Inches	
	Min	Max	Min	Max
A	1.35	1.75	0.053	0.069
A ₁	0.10	0.25	0.004	0.010
b	0.35	0.45	0.014	0.018
C	0.18	0.25	0.007	0.010
D-8	4.69	5.00	0.185	0.196
E	3.50	4.05	0.140	0.160
e	1.27 BSC		0.050 BSC	
H	5.70	6.30	0.224	0.248
L	0.60	0.937	0.024	0.037
∅	0°	8°	0°	8°
S	0.25	0.50	0.010	0.020

PDIP-8 PACKAGE DRAWING

8 Pin Plastic DIP Package

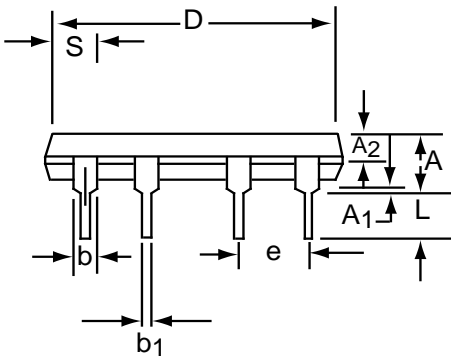
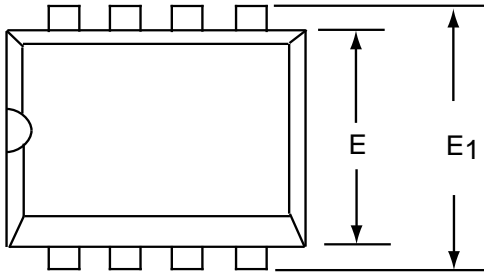

Dim	Millimeters		Inches	
	Min	Max	Min	Max
A	3.81	5.08	0.105	0.200
A ₁	0.38	1.27	0.015	0.050
A ₂	1.27	2.03	0.050	0.080
b	0.89	1.65	0.035	0.065
b ₁	0.38	0.51	0.015	0.020
c	0.20	0.30	0.008	0.012
D-8	9.40	11.68	0.370	0.460
E	5.59	7.11	0.220	0.280
E ₁	7.62	8.26	0.300	0.325
e	2.29	2.79	0.090	0.110
e ₁	7.37	7.87	0.290	0.310
L	2.79	3.81	0.110	0.150
S-8	1.02	2.03	0.040	0.080
∅	0°	15°	0°	15°

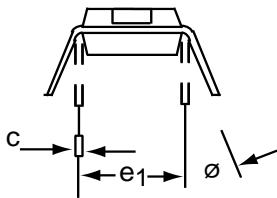

CERDIP-8 PACKAGE DRAWING

8 Pin CERDIP Package

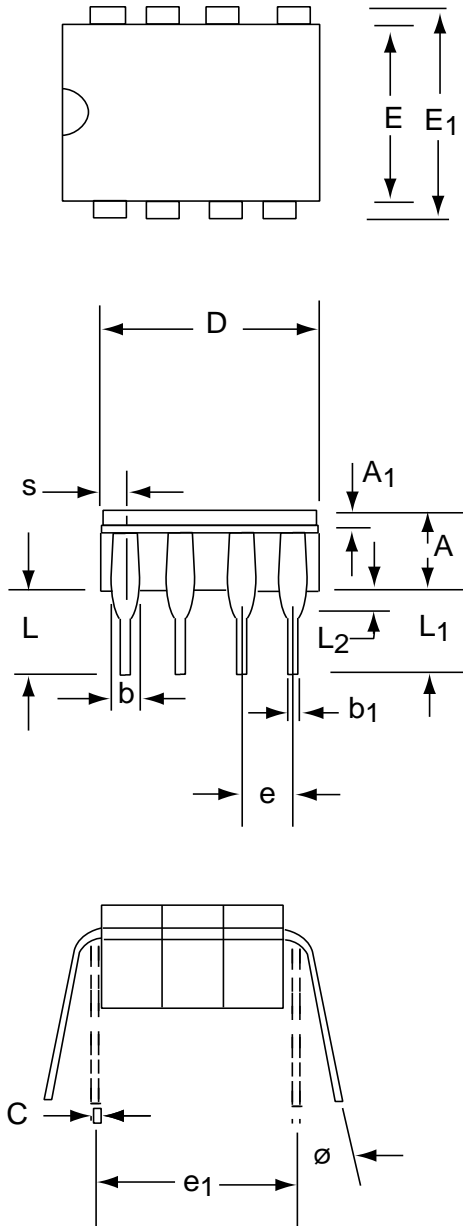

Dim	Millimeters		Inches	
	Min	Max	Min	Max
A	3.55	5.08	0.140	0.200
A ₁	1.27	2.16	0.050	0.085
b	0.97	1.65	0.038	0.065
b ₁	0.36	0.58	0.014	0.023
C	0.20	0.38	0.008	0.015
D-8	--	10.29	--	0.405
E	5.59	7.87	0.220	0.310
E ₁	7.73	8.26	0.290	0.325
e	2.54 BSC		0.100 BSC	
e ₁	7.62 BSC		0.300 BSC	
L	3.81	5.08	0.150	0.200
L ₁	3.18	--	0.125	--
L ₂	0.38	1.78	0.015	0.070
S	--	2.49	--	0.098
∅	0°	15°	0°	15°